

# Service Manual

AV Control Stereo Receiver



Receiver

## SA-EX510

Colour

(K) ..... Black Type

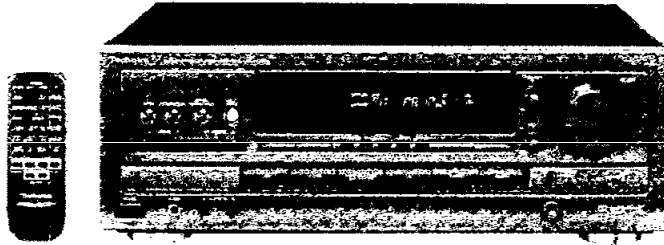

Area

Suffix for Model No.	Area	Colour
(E)	Europe	(K)
(EB)	Great Britain	
(EG)	Germany and Italy	

\* Manufactured under license from Dolby Laboratories Licensing Corporation. Additionally licensed under one or more of the following patents: U.S. numbers 3,632,886, 3,746,792 and 3,959,590; Canadian numbers 1,004,603 and 1,037,877.

"Dolby" and the double-D symbol are trade marks of Dolby Laboratories Licensing Corporation.

## Specifications

### Amplifier Section

Power output	
DIN 1kHz (T.H.D. 1%)	2x100W (4Ω)
20 Hz-20 kHz continuous power output both channels driven	2 x 65W (8Ω)
Total harmonic distortion	
Rated power at 20 Hz - 20kHz	0.05% (8Ω)
Half power at 1 kHz	0.03% (8Ω)
Power output at the Dolby Pro Logic operation	
DIN 1 kHz (T.H.D. 1%)	
Front	2X60W (4Ω)
Center	60W (8Ω)
Surround	60W (8Ω)
Intermodulation distortion rated power at 60Hz: 7kHz = 4:1, SMPTE	0.5% (8Ω)
Power bandwidth both channels driven, -3dB	10Hz - 40kHz(8Ω)
Damping factor	30 (8Ω)
Load impedance	
Front	
A or B	4-16Ω
A and B	8-16Ω
Center	8-16Ω
surround	4-16Ω
Frequency response	
PHONO	RIAA standard curve(30Hz - 15kHz) ± 0.8dB
CD, TAPE, VCR, TV/DVD	10Hz - 40kHz, ± 3dB
Input sensitivity and impedance	
PHONO	3mV/47kΩ
CD, TAPE, VCR, TV/DVD	200mV/22kΩ
S/N at rated power (8Ω)	
PHONO	70dB (IHF, A: 80dB)
CD, TAPE, VCR, TV/DVD	75dB (IHF, A: 85dB)
Tone controls	
BASS	50Hz, +10 to -10dB
TREBLE	20kHz, +10 to -10dB
Output voltage	
TAPE REC (OUT), VCR OUT	200mV

Channel balance (250Hz-6.3kHz)	±1dB
Channel separation	55dB
Headphone output level and impedance	430mV/330Ω
Subwoofer frequency response	7Hz - 100Hz, ±3dB

### FM Tuner Section

Frequency range	87.50 - 108.00MHz
Sensitivity	
S/N 30dB	1.5μV/75Ω
S/N 26dB	1.3μV/75Ω
S/N 20dB	1.2μV/75Ω
IHF usable sensitivity	1.5μV/75Ω (IHF '58)
IHF 46dB stereo quieting sensitivity	22μV/75Ω
Total harmonic distortion	
MONO	0.2%
STEREO	0.3%
S/N	
MONO	60dB (75dB, IHF)
STEREO	58dB (71dB, IHF)
Frequency response	20Hz - 15 kHz, +1dB, -2dB
Alternate channel selectivity	
±400 kHz	65dB
Capture ratio	1dB
Image rejection at 98MHz	40dB
IF rejection at 98MHz	70dB
Spurious response rejection at 98MHz	70dB
AM suppression	50dB
Stereo separation	
1 kHz	40dB
Carrier leak	
19kHz	-30dB (-35dB, IHF)
38kHz	-50dB (-55dB, IHF)
Channel balance (250Hz - 6.3kHz)	±1.5dB
Limiting point	1.2μV
Bandwidth	
IF amplifier	180kHz
FM demodulator	1000kHz
Antenna terminal(s)	75Ω (unbalanced)

# Technics®

© 1997 Matsushita Electronics (S) Pte. Ltd.  
All rights reserved. Unauthorized copying and distribution is a violation of law.

**⚠ WARNING**

This service information is designed for experienced repair technicians only and is not designed for use by the general public. It does not contain warnings or cautions to advise non-technical individuals of potential dangers in attempting to service a product. Products powered by electricity should be serviced or repaired only by experienced professional technicians. Any attempt to service or repair the product or products dealt with in this service information by anyone else could result in serious injury or death.

**■ AM Tuner Section**

Frequency range	522 — 1611kHz (9kHz steps)
AM	530 — 1620kHz (10kHz steps)
Sensitivity	20 $\mu$ V, 330 $\mu$ V/m
Selectivity (at 999kHz)	55dB
Image rejection (at 999kHz)	40dB
IF rejection (at 999kHz)	55dB

**■ Video Section**

Output voltage at 1 V input (unbalanced)	1 $\pm$ 0.1 Vp-p
Maximum input voltage	1.5 Vp-p
Input/output impedance	75 $\Omega$ (unbalanced)

**■ Contents**

	PAGE		PAGE
• BEFORE REPAIR AND ADJUSTMENT.....	2	• TERMINAL GUIDE OF ICs, TRANSISTORS & DIODES..	18 & 19
• PROTECTION CIRCUITRY.....	2	• SCHEMATIC DIAGRAM.....	19 ~ 32
• CAUTION FOR AC MAINS LEAD .....	3	• PRINTED CIRCUIT BOARD .....	33 ~ 39
• OPERATION CHECKS AND MAIN COMPONENT REPLACEMENT	4 ~ 8	• WIRE CONNECTION DIAGRAM.....	40
• FAN MOTOR TROUBLESHOOTING.....	9	• CABINET PARTS LOCATION.....	41
• TROUBLESHOOTING.....	10 ~ 13	• REPLACEMENT PARTS LIST.....	42 ~ 44
• BLOCK DIAGRAM.....	14 ~ 17	• RESISTORS & CAPACITORS.....	44 ~ 48
• TERMINAL FUNCTIONS OF ICs.....	18	• PACKAGING.....	48

**■ Before Repair and Adjustment**

Disconnect AC power, discharge 4 Power Supply Capacitors C703, C704, C705 and C706 through a 10 $\Omega$ , 5W resistor to ground. DO NOT SHORT-CIRCUIT DIRECTLY (with a screwdriver blade, for instance), as this may destroy solid state devices. After repairs are completed, restore power gradually using a variac, to avoid overcurrent.

**■ Protection Circuitry**

The protection circuitry may have operated if either of the following conditions are noticed:

- No sound is heard when the power is turned on.
- Sound stops during a performance.

The function of this circuitry is to prevent circuitry damage if, for example, the positive and negative speaker connection wires are "shorted", or if speaker systems with an impedance less than the indicated rated impedance of the amplifier are used.

If this occurs, follow the procedure outlines below:

1. Turn off the power.
2. Determine the cause of the problem and correct it.
3. Turn on the power once again after one minute.

**Note:**

When the protection circuitry functions, the unit will not operate unless the power is first turned off and then on again.

**■ General**

Power consumption	180W
Power supply	AC 230V, 50Hz
for E, EG area	AC 230-240V, 50Hz
for EB area	430 x 158 x 312 mm
Dimensions (W x H x D)	8.8 kg
Weight	

**Notes :**

1. Specifications are subject to change without notice. Weight and dimensions are approximate.
2. Total harmonic distortion is measured by the digital spectrum analyzer.

## Caution for AC Mains Lead



(For "EB" area code model only.)

For your safety, please read the following text carefully.

This appliance is supplied with a moulded three pin mains plug for your safety and convenience.

A 5-ampere fuse is fitted in this plug.

Should the fuse need to be replaced please ensure that the replacement fuse has a rating of 5-ampere and that it is approved by ASTA or BSI to BS1362.

Check for the ASTA mark  or the BSI mark  on the body of the fuse.

If the plug contains a removable fuse cover you must ensure that it is refitted when the fuse is replaced.

If you lose the fuse cover, the plug must not be used until a replacement cover is obtained.

A replacement fuse cover can be purchased from your local dealer.

### CAUTION !

IF THE FITTED MOULDED PLUG IS UNSUITABLE FOR THE SOCKET OUTLET IN YOUR HOME THEN THE FUSE SHOULD BE REMOVED AND THE PLUG CUT OFF AND DISPOSED OFF SAFELY.

THERE IS A DANGER OF SEVERE ELECTRICAL SHOCK IF THE CUT OFF PLUG IS INSERTED INTO ANY 13-AMPERE SOCKET.

If a new plug is to be fitted, please observe the wiring code as shown below.

If in any doubt please consult a qualified electrician.

### IMPORTANT

The wires in this mains lead are coloured in accordance with the following code:

Blue: Neutral  
Brown: Live

As these colours may not correspond with the coloured markings identifying the terminals in your plug, proceed as follows:

The wire which is coloured Blue must be connected to the terminal which is marked with the letter N or coloured Black or Blue.

The wire which is coloured Brown must be connected to the terminal which is marked with the letter L or coloured Brown or Red.

**WARNING: DO NOT CONNECT EITHER WIRE TO THE EARTH TERMINAL WHICH IS MARKED WITH THE LETTER E, BY THE EARTH SYMBOL  OR COLOURED GREEN OR GREEN/YELLOW.**

**THIS PLUG IS NOT WATERPROOF—KEEP DRY.**

### Before use

Remove the connector cover.

### How to replace the fuse

The location of the fuse differ according to the type of AC mains plug (figures A and B). Confirm the AC mains plug fitted and follow the instructions below.

Illustrations may differ from actual AC mains plug.

#### 1. Open the fuse cover with a screwdriver.

Figure A

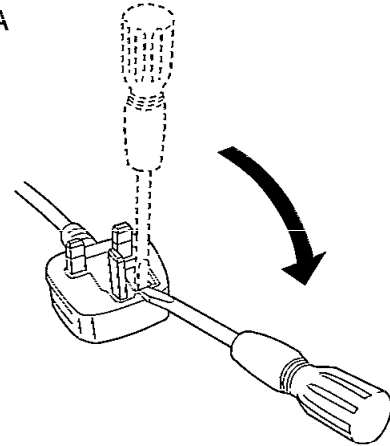
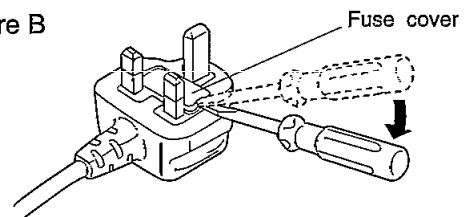

Figure B



#### 2. Replace the fuse and close or attach the fuse cover.

Figure A

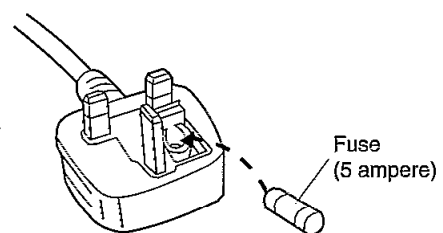
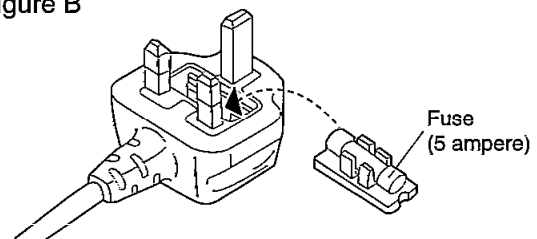

Figure B



## ■ Operation Checks and Main Component Replacement Procedures

**"ATTENTION SERVICER"** Some chassis components may have sharp edges. Be careful when disassembling and servicing.

1. This section describes procedures for checking the operation of the major printed circuit boards and replacing the main components.
2. For reassembly after operation checks or replacement, reverse the respective procedures. Special reassembly procedures are described only when required.
3. Select items from the following index when checks or replacement are required.

### • Contents

	page
• Checking Procedure For Each Major P.C.B. ....	3 ~ 5
• Main Component Replacement Procedures .....	5 ~ 7

## ■ Checking Procedure For Each Major P.C.B.

### 1. Checking of the Panel P.C.B., and Tuner P.C.B.

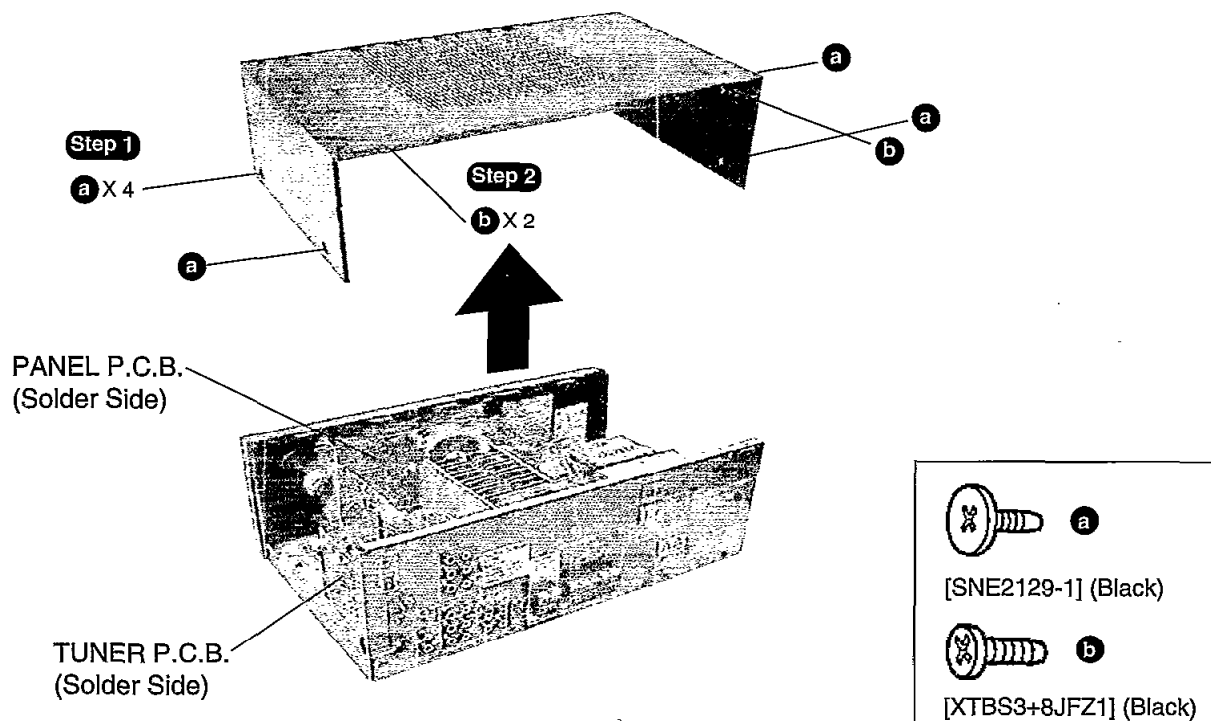

### 2. Checking of the Pro Logic P.C.B.

**Step 1**  
Remove the top cabinet.

**Step 3**  
Release the catch, pull the rear panel in the direction of arrow ① and simultaneously remove the tuner P.C.B. in the direction of arrow ②.

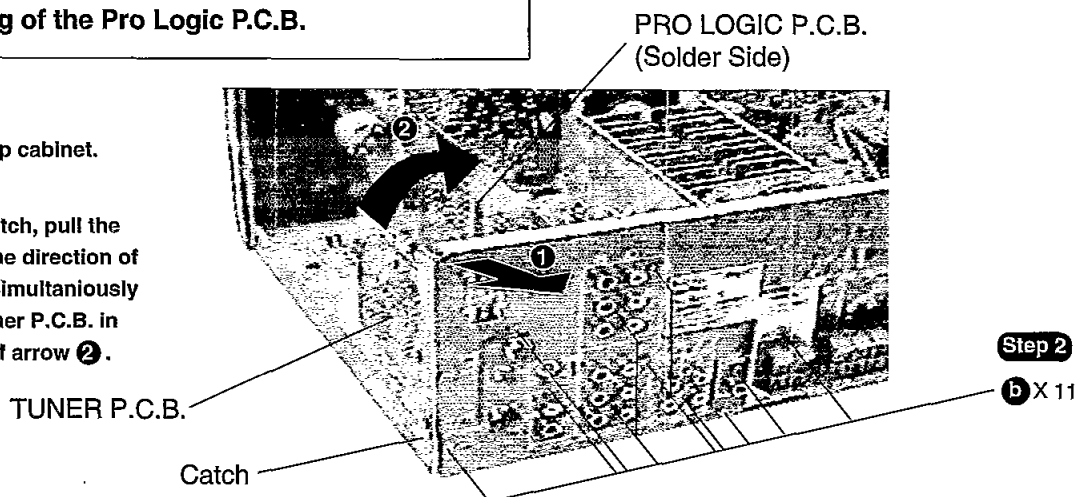

**To Remove Front Panel, Panel P.C.B., Power Switch P.C.B. and Headphone Jack P.C.B.**

**Step 1**  
Remove the top cabinet.

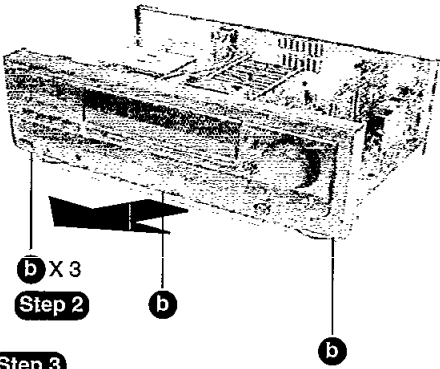

**b X 3**  
**Step 2**

**Step 3**  
Remove the front panel in the direction of arrow.

Power Switch P.C.B.

Headphone Jack P.C.B.

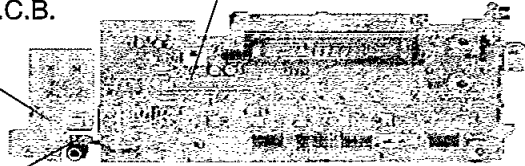

**Step 4**  
Remove the Volume Knob and Nut.

**Step 6**

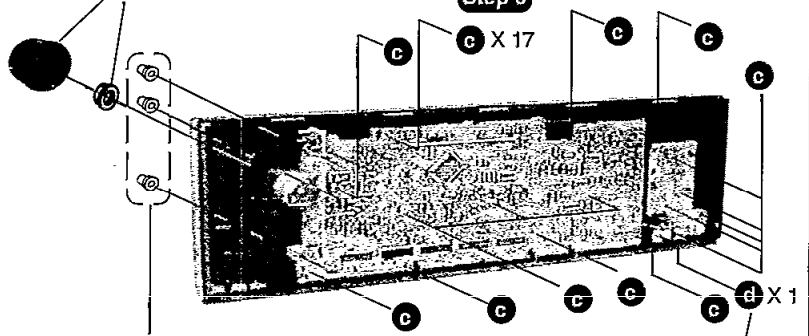

**Step 5**  
Pull out 3 knobs.

Panel P.C.B.

**Step 7**

**Step 8**  
Pull out the Headphone Jack P.C.B.

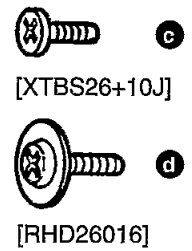

**3. Checking of the MAIN P.C.B.**

**Step 1**  
Remove the top cabinet.

**Step 2**  
Remove the front panel.

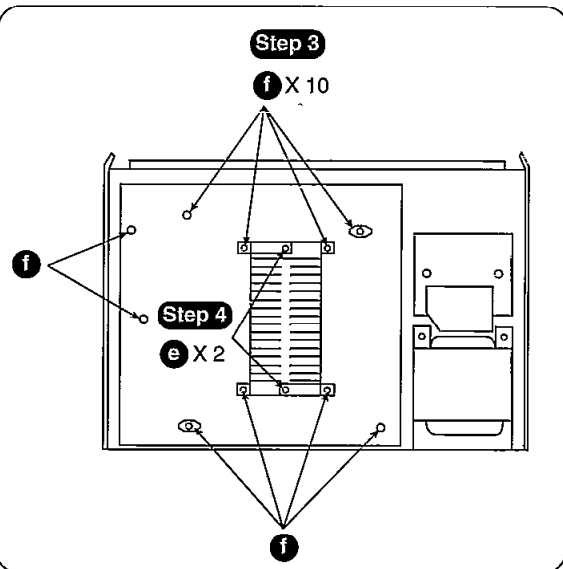

**Step 6**  
Release 2 catches and pull the rear panel in the direction of arrow ① for about 10mm.  
(Note : Main, Tuner and Pro Logic P.C.B. are attach to the rear panel)

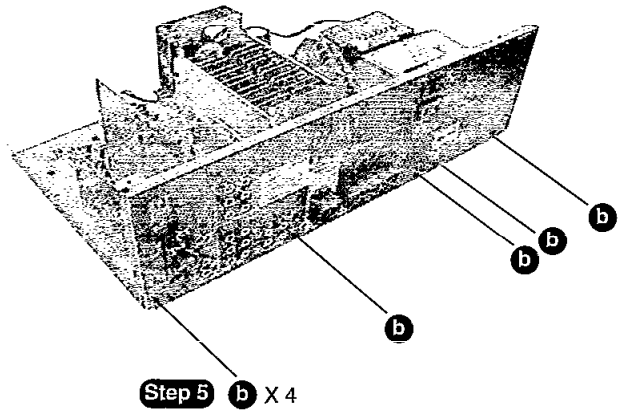

**Step 7**  
Lift the rear panel in the direction of arrow ②.

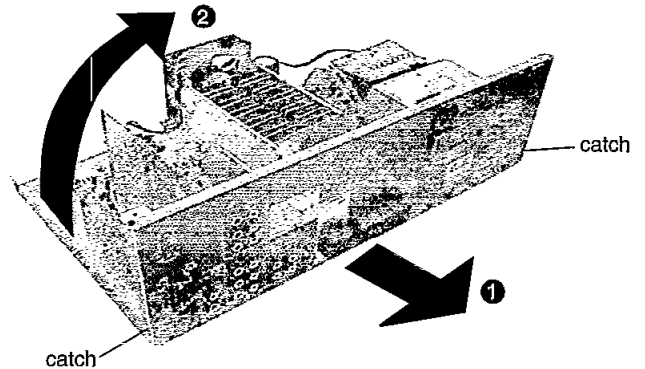

**Step 8**

Connect the front panel to the main P.C.B. as shown.

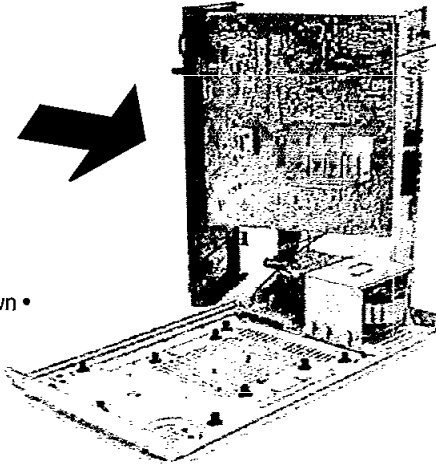

MAIN P.C.B. (Solder Side)

• Check the Main P.C.B. as shown •



[XTB3+8FFZ] (Black)

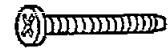

[XTB3+20JFZ] (Black)

**■ Main Component Replacement Procedures**

**1. Replacement of the Power IC and Regulator Transistor**

**Step 1**

Remove the top cabinet.

**Step 2** Cut the joints as shown below. (6 joints)

Locate the nipper to the thin portion of the joint.

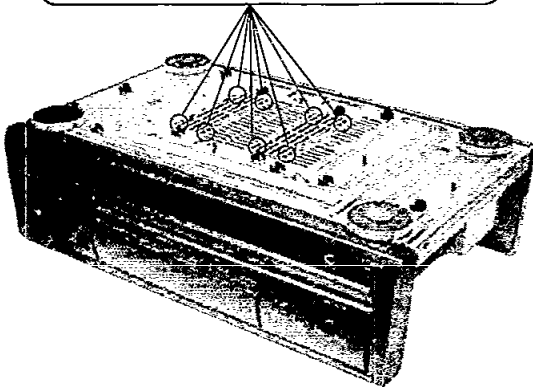
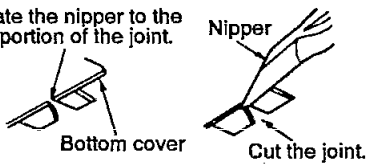

**Step 3** Fold the joints. (6 joints)

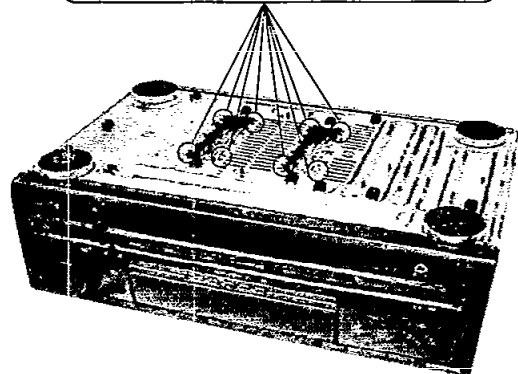
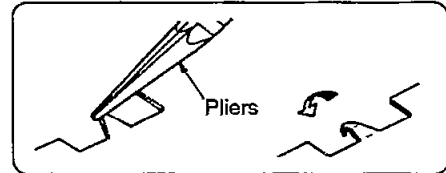

**Step 4**

Desolder the terminals of Power IC and Regulator Transistor.

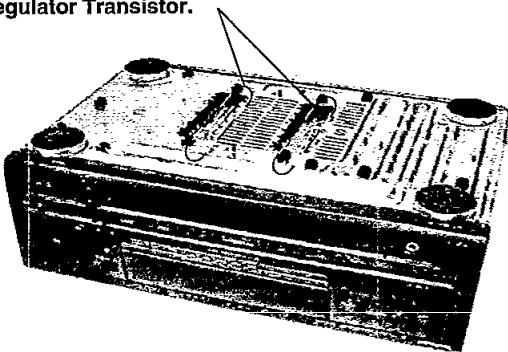

**Step 5**

**g** X 2

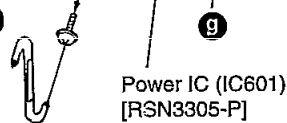

Power IC (IC601)  
[RSN3305-P]

Regulator transistor  
(Q701,Q708)  
[2SD2374PQAU,2SB1548PQAU]

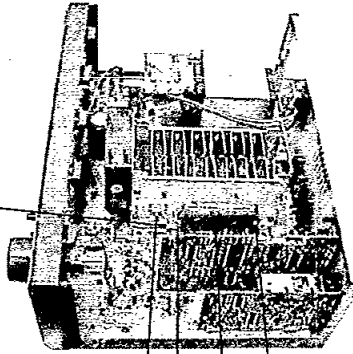

Step 5  
9 X 3



9

9

Power IC (IC602)  
[RSN3305-P]



9

[XTW3+15T]

**Installation of the bottom cover after replacement**

Step 1

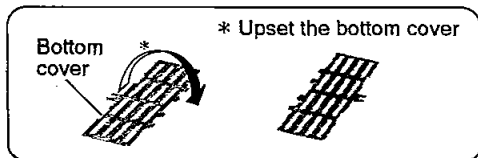

\* Upset the bottom cover

Bottom cover

Step 3

Screw (XTB3+8J)  
(Prepare this screw to fix the bottom cover.)

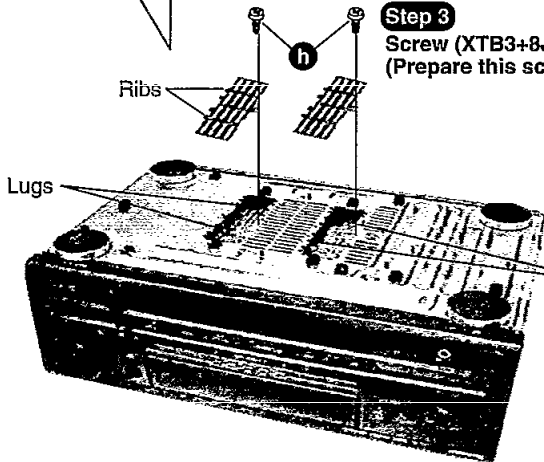

Ribs

Lugs

Step 2

Align the ribs of bottom cover into the lugs.



h

[XTB3+8J] (Black)

**CAUTION**

1. After replacing the power IC or regulator transistor, apply a sufficient quantity of compound grease (RFKX0002/SZZ0L15) between the heat sink and the power IC or regulator transistor (Radiation of power IC).
2. Tighten enough the screws (9) after replacing the power IC and regulator transistor. Otherwise, the heat radiation works little.
3. When installing or removing the power IC or transistor holder, be sure to use an offset screwdriver.

- A long straight screwdriver cannot be used for removing or mounting the screws since its long grip interferes with the neighbouring P.C.B. and transformer.(See Fig.1 & 3)
- A short straight screwdriver may be used for removal, but cannot be used for mounting because the limited space in the unit will not allow sufficient tightening torque.(See Fig.2 & 3)

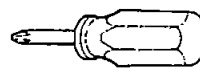

A short straight screwdriver

Fig.2

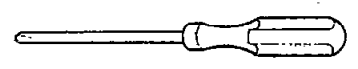

A long straight screwdriver

Fig.1

- Insufficient tightening will cause poor heat dissipation from the power IC and regulator transistor and, in the worst case, may lead to their thermal breakdown.

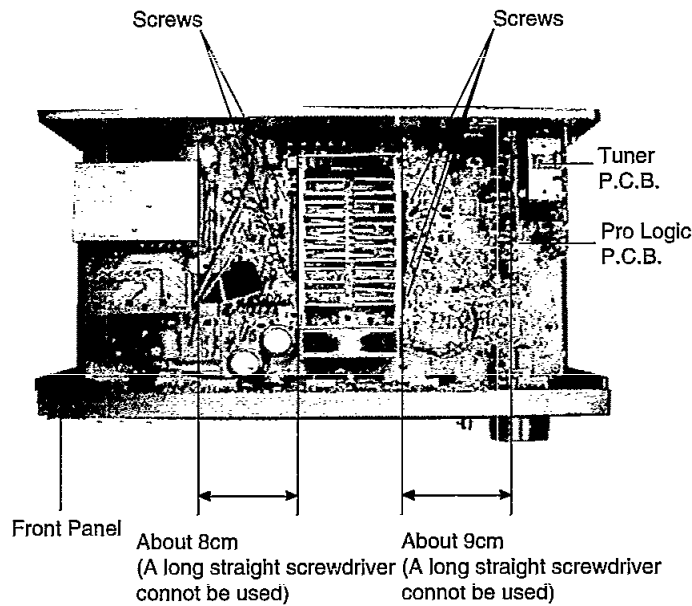
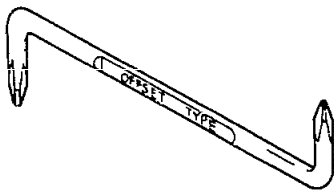

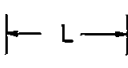

Fig.3

—OFFSET SCREWDRIVER—

•The PROTO offset screwdriver No.34-1/4 is recommended for use in the application above.



No.		
34 1/4	1 & 2	4 3/4"

•The address of PROTO International Sales is as follows.



International Sales

International Sales Office  
Stanley-Proto Industrial Tools  
14117 Industrial Park Blvd.  
Covington, GA 30209 U.S.A.  
Fax: 706-786-4387  
Phone: 706-787-3800

Australia, New Zealand &  
South Pacific  
Stanley-Proto Industrial Tools  
P.O.Box 10  
400 Whitehorse Road  
Nunrweding 3131  
Victoria, Australia  
Fax: 61-3-894-1173  
Phone: 61-3-878-9244

Singapore, Indonesia,  
Philippines, Korea, Hong  
Kong, Malaysia, China.  
Stanley-Proto Asia Pacific  
12 Gul Drive  
Singapore 2262  
Fax: 65-861-3206  
Phone: 65-862-0883

Thailand  
Stanley-Proto Thailand Ltd.  
1017 Moo 13 Bangkaew  
Amphur Bangplee  
Samutprakarn, Thailand  
Fax: 66-2-316-6071  
Phone: 66-2-316-8655

Japan  
Stanley Works Japan  
2-7-16 Hyakunin-Cho  
Shinjuku-ku  
Tokyo 160 Japan  
Fax: 81-3-3360-8456  
Phone: 81-3-3360-8458

Mexico  
Herramientas Stanley S.A.  
DE C.V.  
Apartado Postal 675  
72030 Puebla, Pue, Mexico  
Fax: 52-22-494-4880  
Phone: 52-22-495-300

South & Central America,  
Puerto Rico, The Caribbean  
Stanley Inter-America  
2101 N.W. 84th Ave.  
Miami, Florida 33122  
Fax: 305-594-4261  
Phone: 305-591-3828

Europe  
Stanley-Proto Europe  
Woodside, Sheffield  
539PD  
England  
Fax: 44-742-739-038  
Phone: 44-742-768-888

Canada  
Stanley-Proto Canada  
1100 Corporate Drive  
Burlington, Ontario  
Canada, L7L 5R6  
Fax: 416-335-0075  
Phone: 416-335-0075

Middel East, Mediterranean  
& Africa  
Stanley-MEMA  
Cory House The Ring  
Bracknell Berkshire  
RG 12 1A2  
England  
Fax: 44-344-485-526  
Phone: 44-344-51813



# Fan Motor Troubleshooting

The Model SA-EX500 employ fan motor error sensing electronics.

If the cooling fan is not operating and "OVER LOAD" is displayed on the FL display, check the fan motor and its driving circuit.

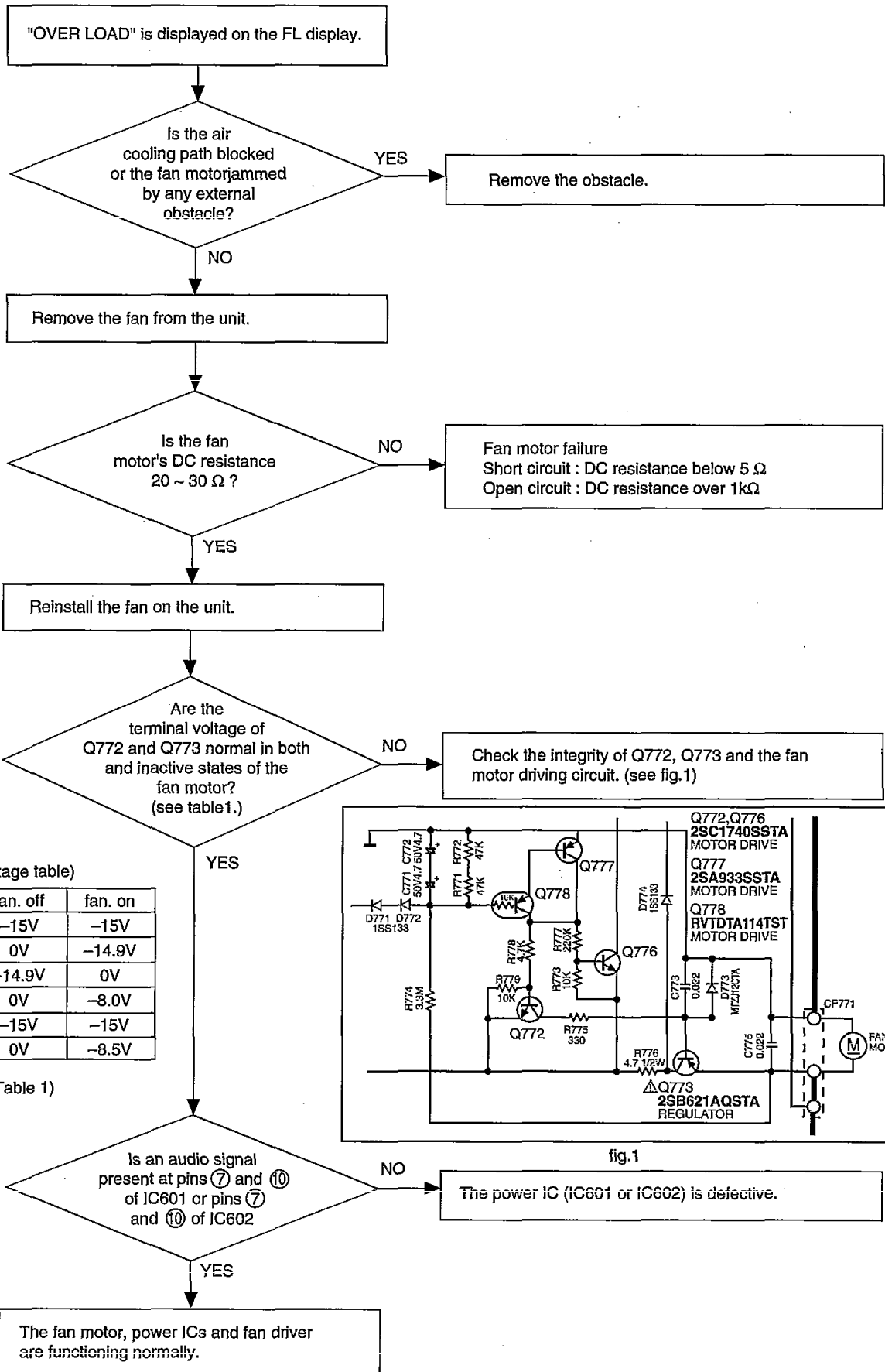

(Voltage table)

		fan. off	fan. on
Q772	E	-15V	-15V
	C	0V	-14.9V
	B	-14.9V	0V
Q773	E	0V	-8.0V
	C	-15V	-15V
	B	0V	-8.5V

(Table 1)

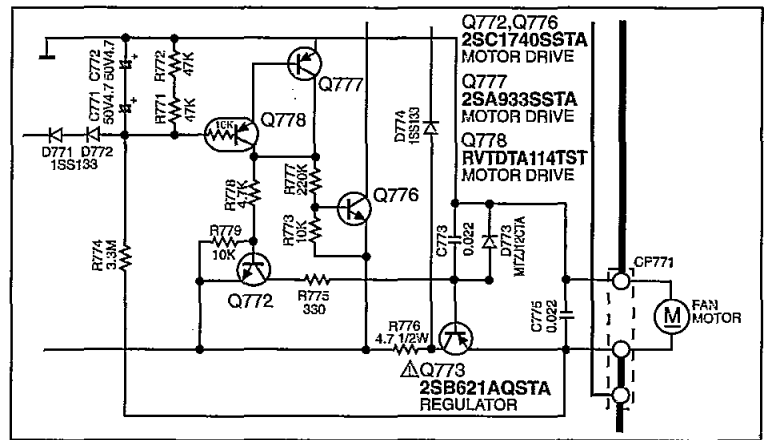

fig.1

## Troubleshooting

This unit has test points on each circuit board block for use in troubleshooting.

### CONNECTION

Connect either a CD player, tape deck or AF oscillator to the input terminals of the unit.

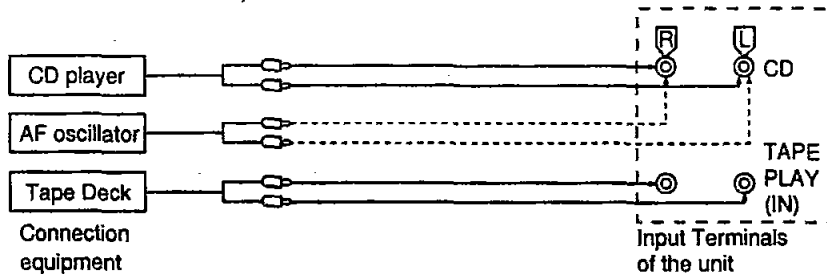

### REQUIRED ITEMS

1. Testing with a CD player ——— Test disc (SZZP1054C / first program, 1kHz, 0dB)
2. Testing with a tape deck ——— Test tape (QZZCLA / 315Hz, 0dB)
3. Testing with a AF oscillator ——— Set the output at 500Hz, 200mV
4. Oscilloscope (min. 10MHz) - - - - - To measure the output waveform at the test points.



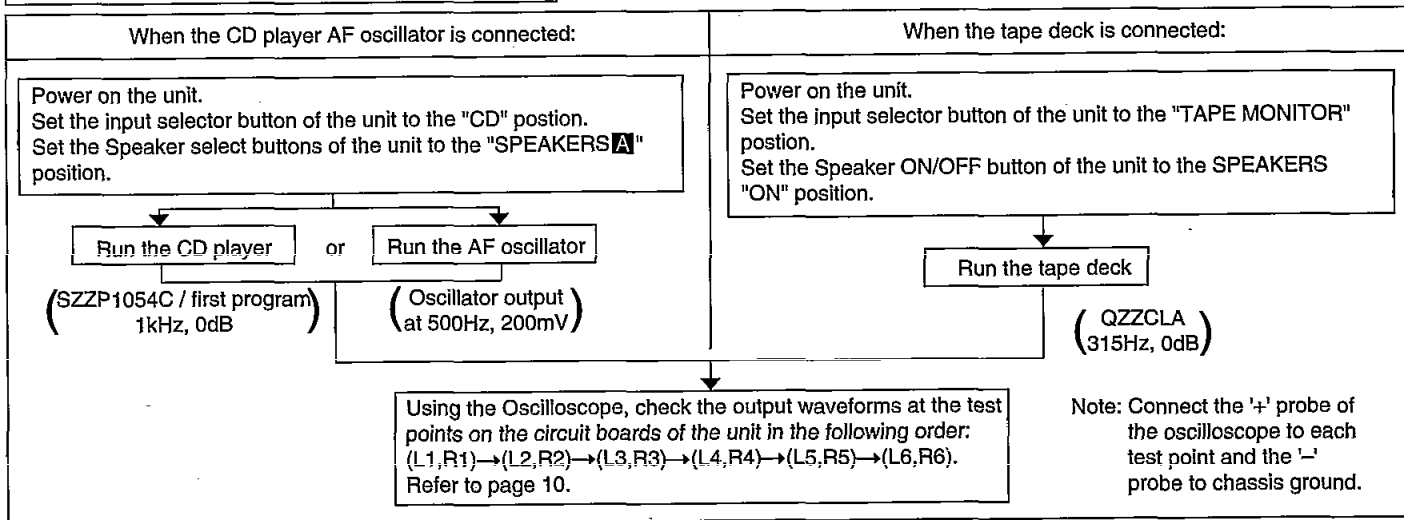



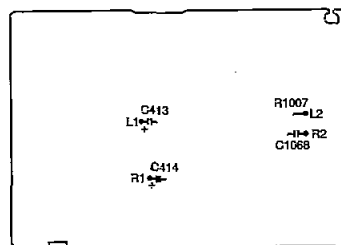
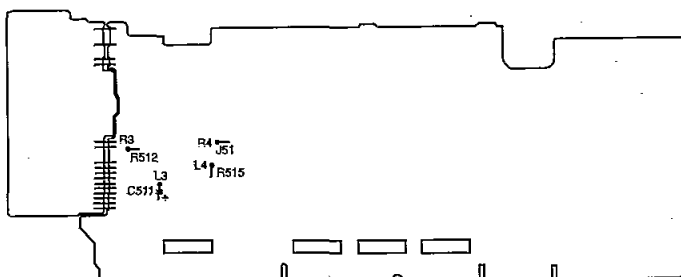
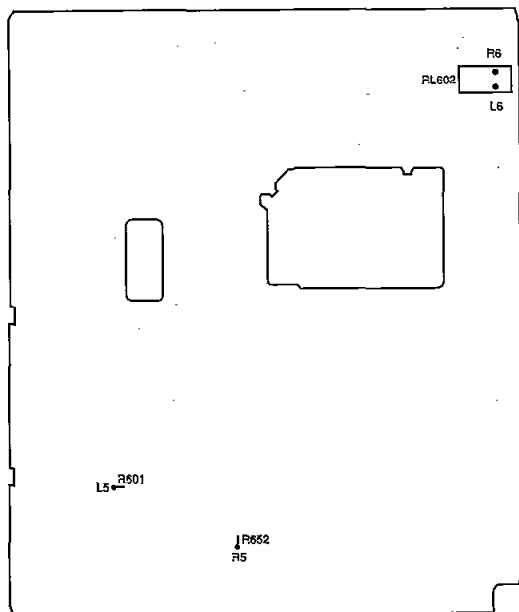

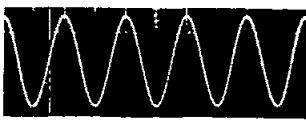

### TEST PROCEDURE FOR AMPLIFIER CIRCUIT

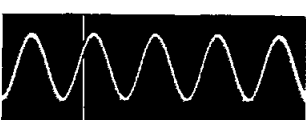
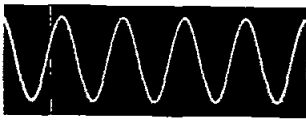

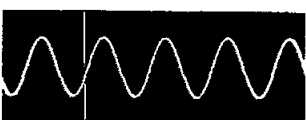
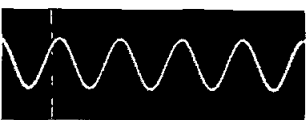
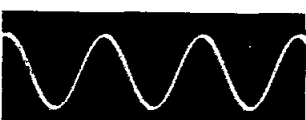

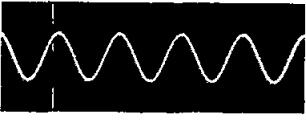
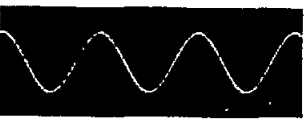
### TEST POINTS POSITIONS OF AMPLIFIER CIRCUIT

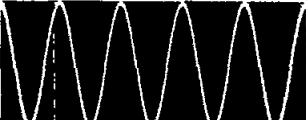

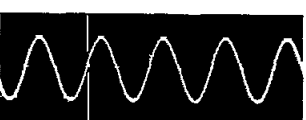
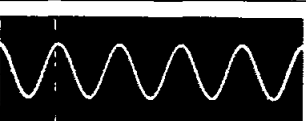
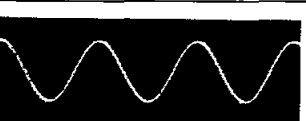
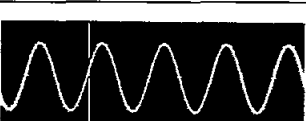
## NORMAL WAVEFORMS OF AMPLIFIER CIRCUIT AND LIKELY FAULTY BLOCKS

TP	CD player	Tape deck	AF oscillator	Likely faulty block if the normal waveform shown at the left is not present.
L1/R1	 0.5msec 2V	 1msec 500mV	 1msec 500mV	Input selector block IC402 & area
L2/R2	 0.5msec 2V	 1msec 500mV	 1msec 500mV	Dolby pro logic block IC1001 and IC1002 & area
L3/R3	 0.5msec 500mV	 1msec 50mV	 1msec 100mV	Master volume block VR501 & area
L4/R4	 0.5msec 500mV	 1msec 1V	 1msec 1V	Tone control block IC511 & area
L5/R5	 0.5msec 100mV*	 1msec 500mV	 1msec 500mV	Power limiter block Q581 to Q584 & area
L6/R6	 0.5msec 5V*	 1msec 10V	 1msec 10V	Main amplifier block IC601 & area

Measurement conditions. Volume control (VR501), Treble control (VR512) and Bass control (VR511) positions :  : 

\*Volume control position (VR501) for these test

## CHECKING PROCEDURE FOR SURROUND CIRCUIT

Outputting surround signal normally requires that opposite phase signals be applied to both the left and right channels. However, this unit incorporates a service mode, allowing the surround circuit to be tested using in-phase signals.

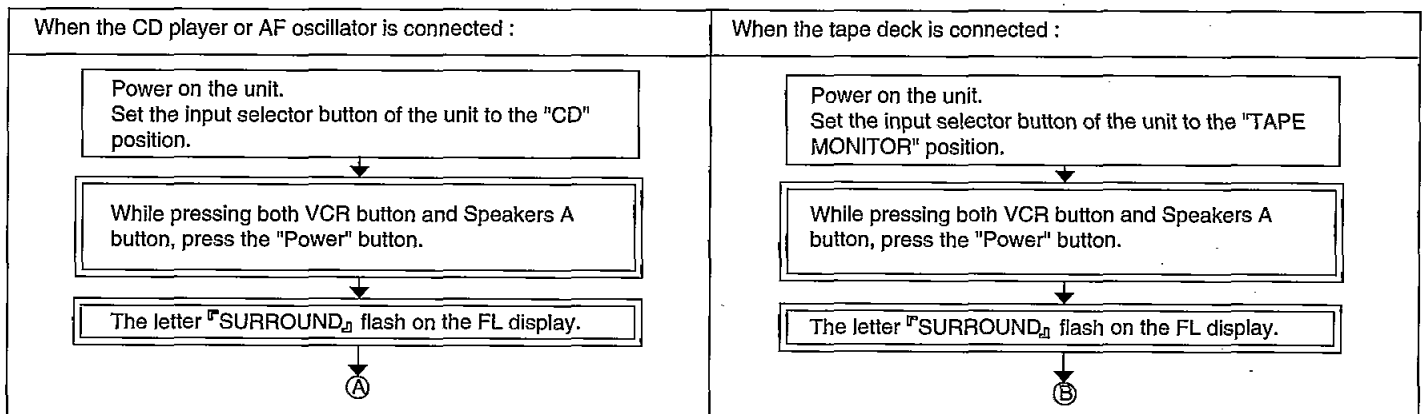

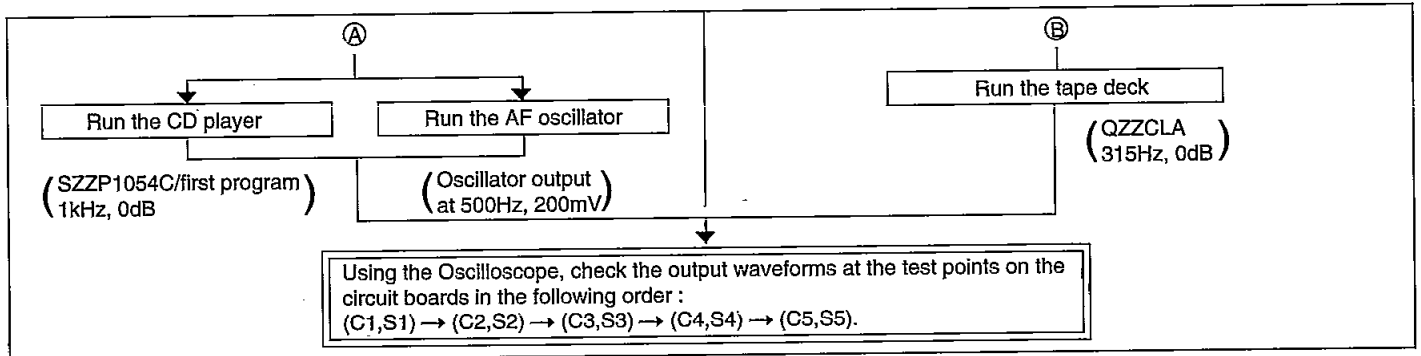

• To exit the service mode, power off the unit.

**TEST POINTS POSITIONS OF SOURROUND CIRCUIT**

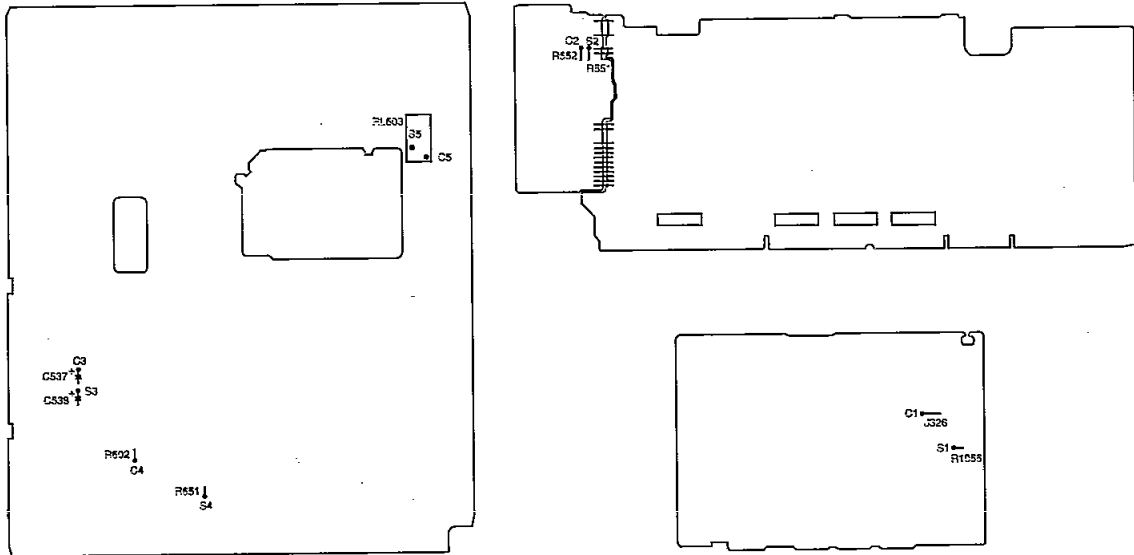

**NORMAL WAVEFORMS OF AMPLIFIER CIRCUIT AND LIKELY FAULTY BLOCKS**

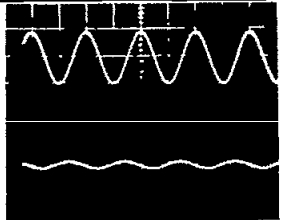
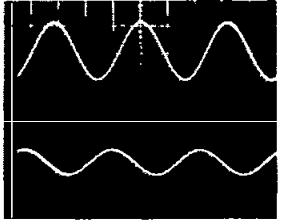
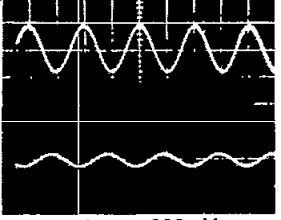
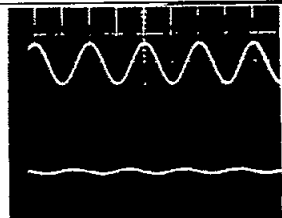
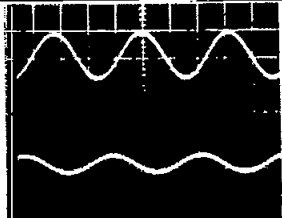
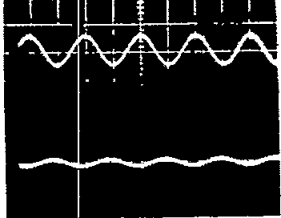
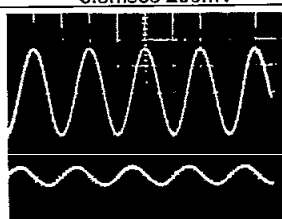
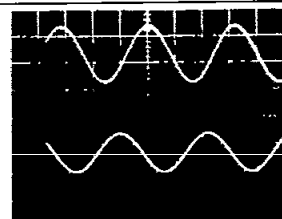
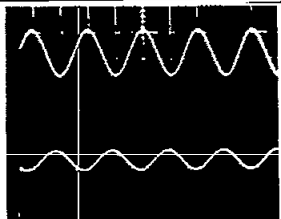
TP	CD player	Tape deck	AF oscillator	Likely faulty block if the normal waveform shown at the left is not present.
C1 S1	 0.5msec 1V	 1msec 100mV	 1msec 200mV	Dolby pro logic block IC1001 and IC1002 & area
C2 S2	 0.5msec 200mV	 1msec 20mV	 1msec 50mV	Master volume block VR501 & area
C3 S3	 0.5msec 200mV*	 1msec 500mV	 1msec 1V	Tone control block IC551 & area

## NORMAL WAVEFORMS OF AMPLIFIER CIRCUIT AND LIKELY FAULTY BLOCKS

TP	CD player	Tape deck	AF oscillator	Likely faulty block if the normal waveform shown at the left is not present.
C4				Power limiter block Q551 to Q552 & area
S4				
C5				Main amplifier block IC601, IC602 & area
S5				

Measurement conditions. Volume control (VR501), Tremble control (VR512) and Bass control (VR511) positions:

\*Volume control position (VR501) for these test

## CIRCUIT BLOCKS

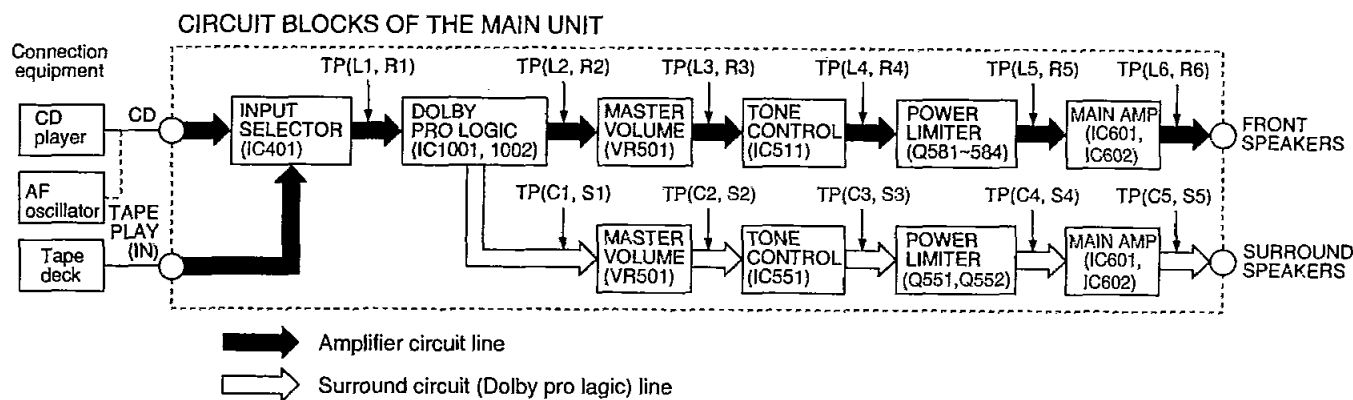

## OVERLOAD DETECTION FUNCTION

The HIC protection circuit functions if any cord at a speaker terminal is short-circuited or if the unit overheats because of improper operation. At the same time, "OVERLOAD" scrolls across the FL display.

In this state, all keys remain in operative; if any key is pressed, "SWITCH OFF POWER" scrolls across the FL display.

If an overload occurs, immediately power off the unit and check the speaker connection, venting holes and cooling fans. After fixing any faults, power on the unit again and check for proper operation.

If no defects are found, or if the unit remains overload after it is power on again, check the circuit for faults.

Block Diagram

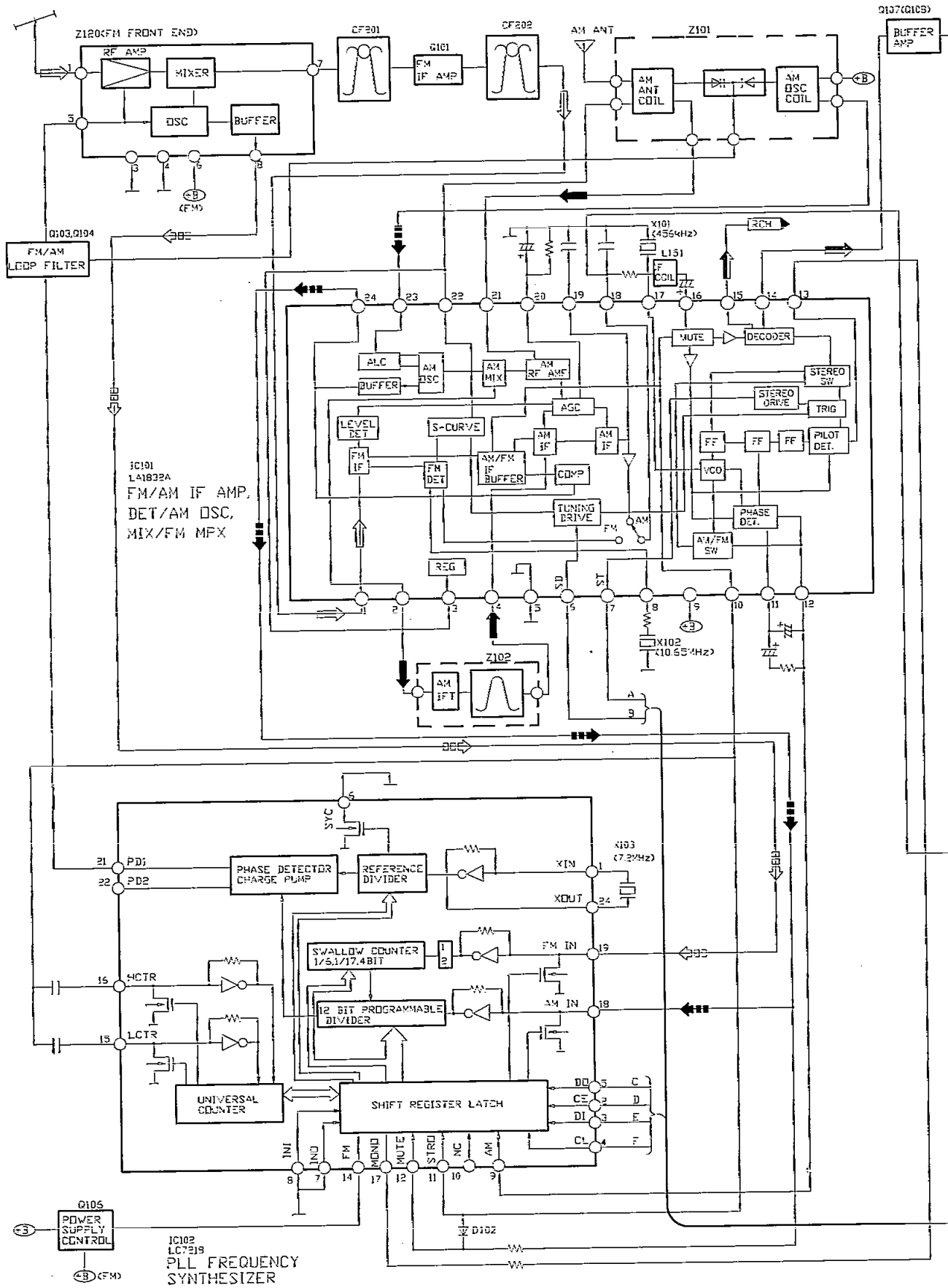

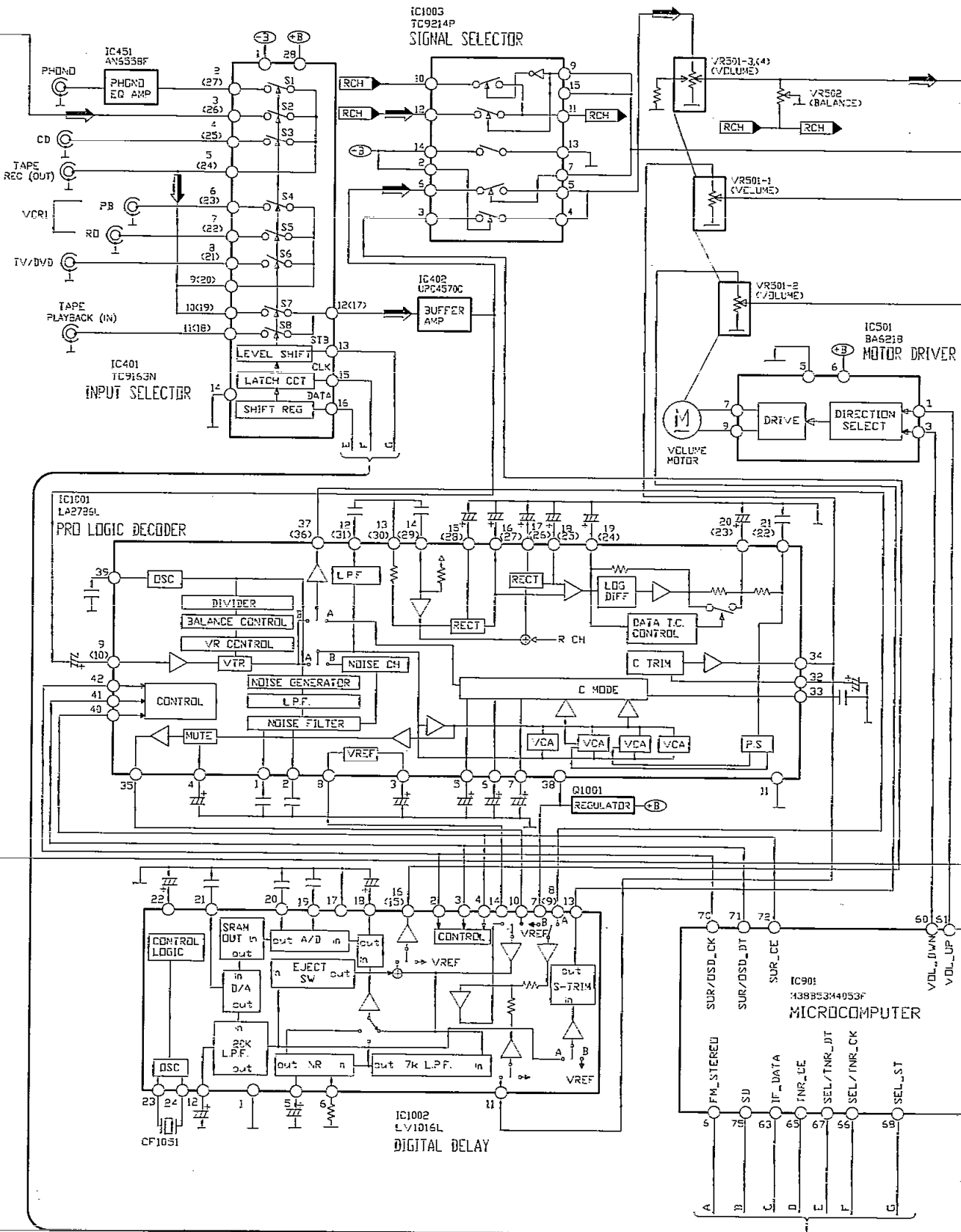

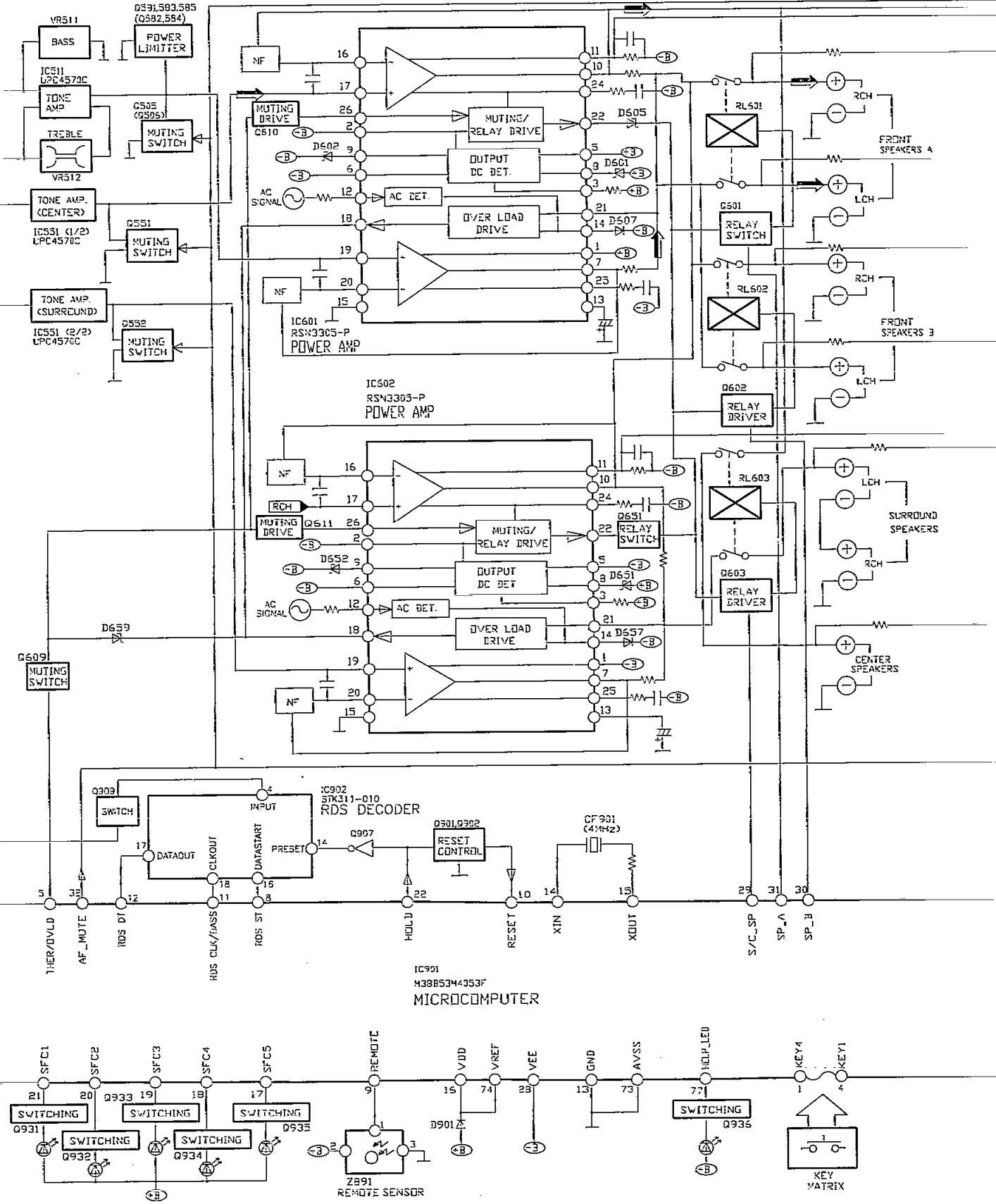



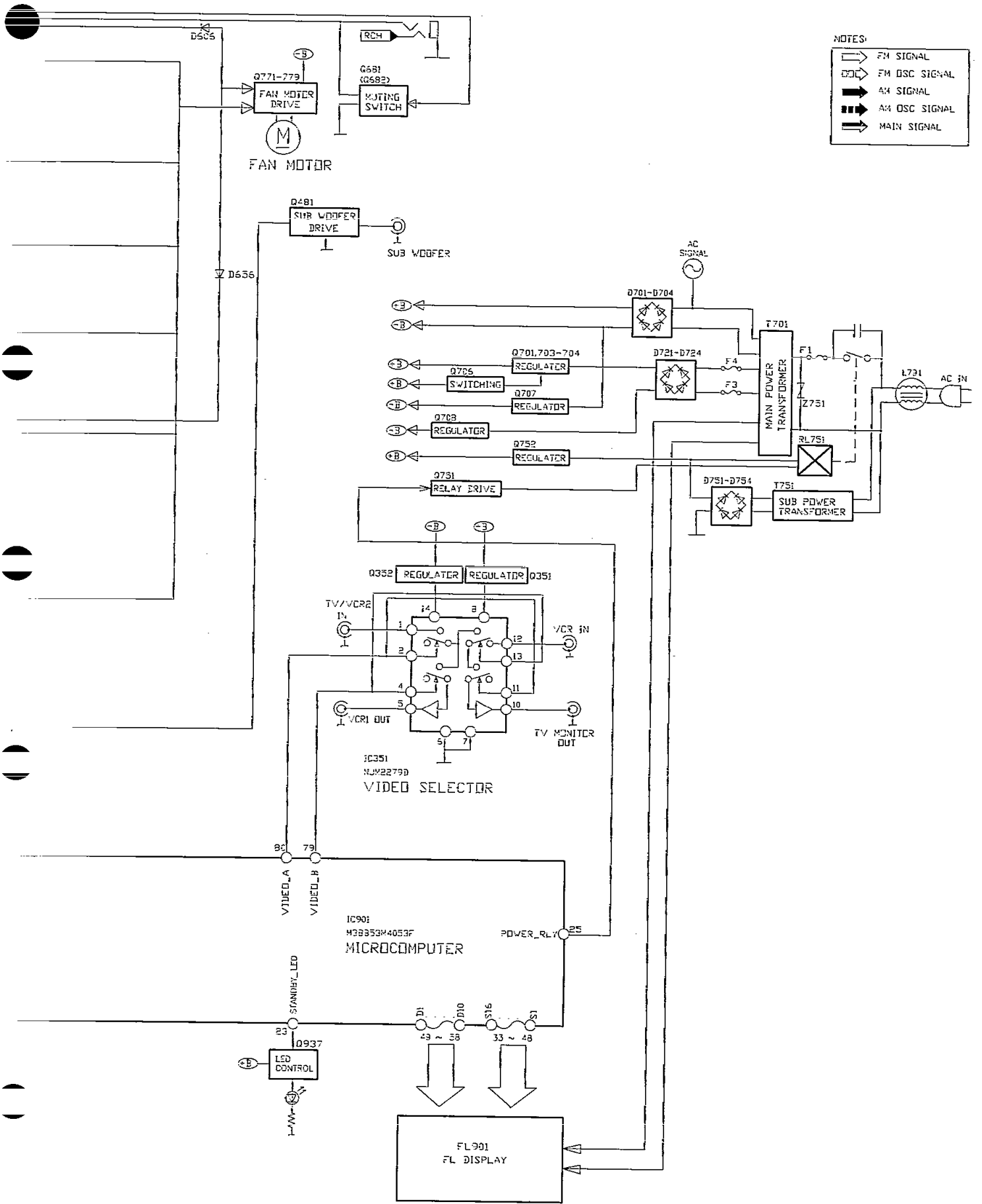
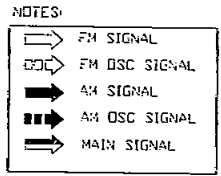

## Terminal Functions Of ICs

### • IC901 (M38B53M4053F) System Microprocessor

Pin No.	Mark	I/O	Function
1-4	KEY4~KEY1	I	Key matrix detect terminal
5	THERM/OVLD	I	Thermal/Over load detect terminal
6	FM_ST	I	Stereo signal detect terminal
7	6CH_ST	-	Not used
8	RDS_ST	-	Not used
9	REMOTE	I	Remote control terminal
10	RESET	I	Reset detect terminal
11	RDS_CK	-	Not used
12	RDS_DT	-	Not used
13	GND	-	GND terminal
14	XIN	I	Crystal oscillator terminal
15	XOUT	O	(4 MHz)
16	VDD	I	Power supply terminal
17-21	SFC5~SFC1	O	SFC LED indicator output
22	HOLD	I	Power trip detection input
23	STANDBY_LED	-	Not used
24	FAN_STOP	-	Not used
25	RLY	O	Power relay control output
26	TV/DVD	I	TV/DVD select control input
27	LIMITER	O	Power limiter control output
28	VEE	I	FL driver pull down voltage
29	S/C_SP	O	Surround/center speaker control output
30	SP_B	O	Speaker B control output
31	SP_A	O	Speaker A control output
32	AF_MUTE	O	Muting control output

Pin No.	Mark	I/O	Function
33-48	SEG16~SEG1	O	FL segment signal output
49-58	DEG1~DEG10	O	FL digit signal output
59	INIT_IN	I	Diode input
60	VOL_DOWN	O	Rotate control terminal of volume motor
61	VOL_UP	O	
62	LOUDNESS	-	Not used
63	IF_DATA	I	Serial data signal
64	REC_MUTE	-	Not used
65	TNR_CE	O	Chip enable signal
66	SEL/TNR_CK	O	Serial clock signal
67	SEL/TNR_DT	O	Serial data signal
68	SEL_ST	O	Level shift control terminal
69	OSD_ST	-	Not used
70	SURR/OSD_CK	O	Serial clock signal
71	SURR/OSD_DT	O	Serial data signal
72	SURR_CE	O	Chip enable signal
73	AVSS	-	GND for A-D converter
74	VREF	I	Reference voltage for A-D conversion
75	SD	I	SD signal detect input
76	AC3_LED	-	Not used
77	HELP_LED	O	LED drive signal (HELP)
78	VIDEO_DET	-	Not used
79	VIDEO_B	O	Video selector control output B
80	VIDEO_A	O	Video selector control output A

## Terminal Guide of ICs, Transistors and Diodes

<p>LA1832A LC7218</p>	<p>NJM2279D</p>	<p>TC9163AN 28Pin</p>	<p>TC9214P</p>	<p>AN6558F UPC4570C</p>	<p>BA6218</p>
<p>RSN3305-P</p>	<p>M38B53M4053F 80 Pin</p>	<p>LA2786L 42Pin</p>	<p>LV1016L</p>	<p>STK311-010</p>	<p>2SB1548PQAU 2SD2374PQAU</p>
<p>2SD592AQSTA 2SB621AQSTA 2SA1534AQRTA 2SC3940AQSTA</p>	<p>2SA933SSTA 2SC1740SSTA RVTDTTC114TST</p>	<p>RVTDTA113ZST RVTDTTC114EST RVTDTA114EST RVTDTTC143XST RVTDTA114TST RVTDTTC114YST RVTDTA114YST RVTDTA143XST</p>	<p>2SC2787LTA 2SC2785FETA 2SC3311ARTA 2SD1915FTA</p>	<p>1N5402BM21 SB360L6508</p>	

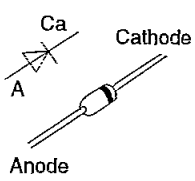
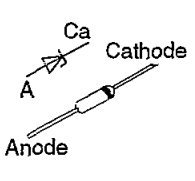
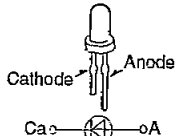
 <p>RVD1SS133TA 1SR35200TB 1SS291TA MA167ATA MA700ATA MA165TA MA723TA</p>	 <p>MTZJ5R1BTA MTZJ5R6BTA MTZJ7R5CTA MTZJ3R0ATA MTZJ6R2BTA MTZJ15CTA</p>	<p>MTZJ6R8BTA MTZJ4R7BTA MTZJ3R9ATA MTZJ10CTA MTZJ27DTA MTZJ9R1CTA</p>	<p>SLR342DC</p> 
--	---	--	---









## ■ Schematic Diagram

(All schematic diagrams may be modified at any time with the development of new technology)

### Note :

- |        |   |                           |                     |   |                                    |
|--------|---|---------------------------|---------------------|---|------------------------------------|
| • S946 | : | Power switch              | • S964              | : | VCR select switch                  |
| • S947 | : | Phono select switch       | • S970              | : | Search switch                      |
| • S948 | : | Muting switch             | • S971              | : | EON switch                         |
| • S950 | : | FM Auto/ Mono switch      | • S972              | : | PTY up switch                      |
| • S951 | : | Band select switch        | • S973              | : | PTY down switch                    |
| • S952 | : | Tuning decrease switch    | • S974              | : | Display switch                     |
| • S953 | : | Tuning increase switch    | • S980              | : | Speakers A switch                  |
| • S955 | : | Memory manual/auto switch | • S981              | : | Speakers B switch                  |
| • S956 | : | Preset decrease switch    | • S983              | : | Dolby Pro Logic/SFC off on switch  |
| • S957 | : | Preset increase switch    | • S984              | : | Dolby Pro Logic mode select switch |
| • S958 | : | Help switch               | • S985              | : | Center mode select switch          |
| • S960 | : | Tuner select switch       | • VR501-1 ~ VR501-4 | : | Volume control                     |
| • S961 | : | CD select switch          | • VR502             | : | Balance control                    |
| • S962 | : | Tape select switch        | • VR511-1 ~ VR511-2 | : | Bass control                       |
| • S963 | : | TV/DVD select switch      | • VR512-1 ~ VR512-2 | : | Treble control                     |

### • Signal line

- |   |   |                  |   |   |                    |   |   |                    |
|---|---|------------------|---|---|--------------------|---|---|--------------------|
|    | : | +B line          |    | : | AM signal line     |    | : | FM signal line     |
|  | : | Main signal line |  | : | AM OSC signal line |  | : | FM OSC signal line |
|  | : | -B line          |  | : | FM/AM signal line  |   |   |                    |

•The voltage value and waveforms are the reference voltage of this unit measured by DC electronic voltmeter (high impedance) and oscilloscope on the basis of chassis.

Accordingly, there may arise some error in voltage values and waveforms depending upon the internal impedance of the tester or the measuring unit.

( ) ..... AM

< > ..... FM

### •Importance safety notice:

Components identified by  mark have special characteristics important for safety. Furthermore, special parts which have purposes of fire-retardant (resistors), high-quality sound (capacitors), low-noise (resistors), etc. are used. When replacing any of components, be sure to use only manufacturer's specified parts shown in the parts list.

### Caution !

IC, LSI and VLSI are sensitive to static electricity.

Secondary trouble can be prevented by taking care during repair.

- Cover the parts boxes made of plastics with aluminium foil.
- Ground the soldering iron.
- Do not touch the pins of IC, LSI or VLSI with fingers directly.
- Put a conductive mat on the work table.

**B** PANEL CIRCUIT

**A**  
TO MAIN CIRCUIT  
(CN901)  
(PAGE 25)

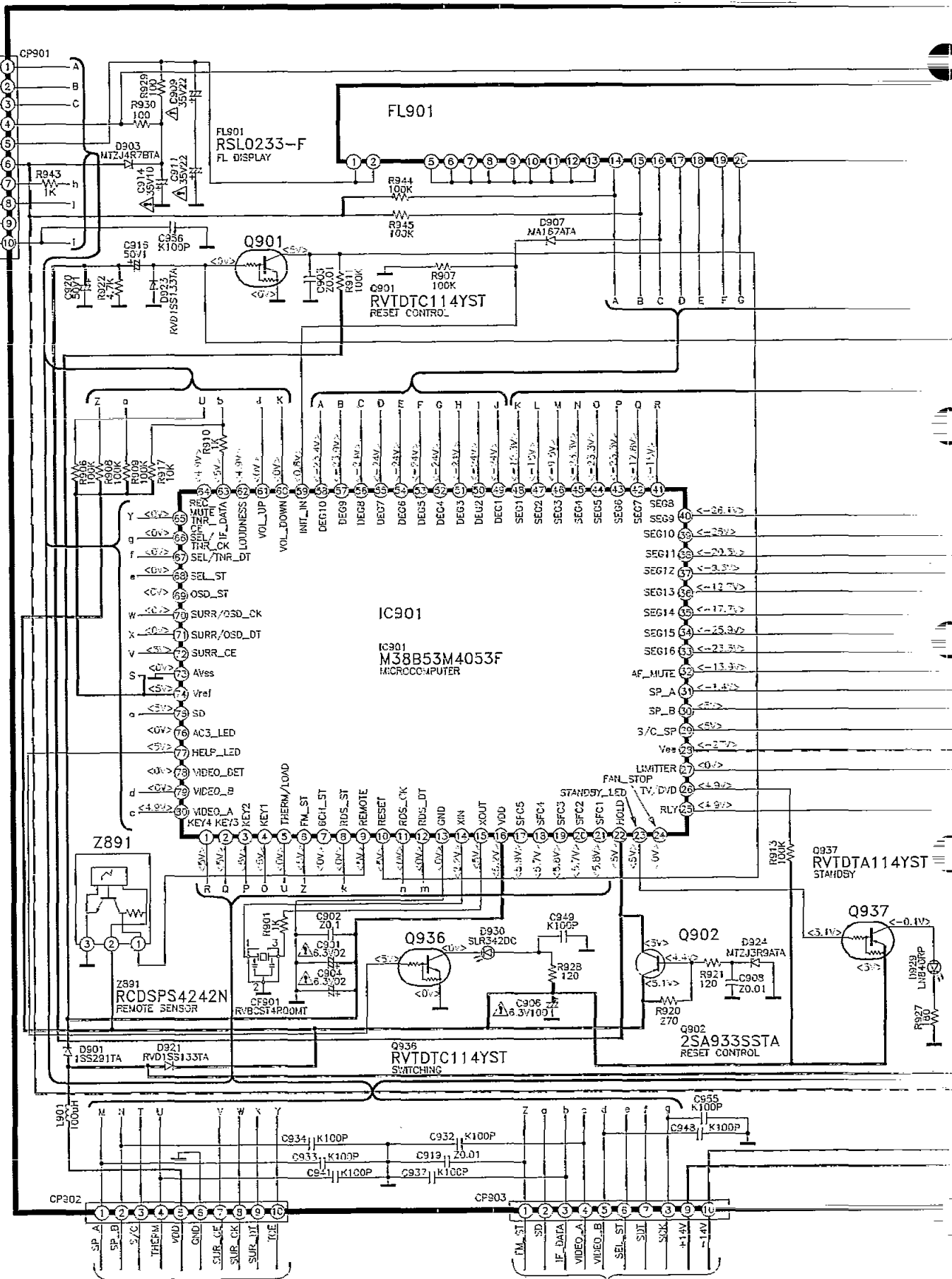

**A**  
TO MAIN CIRCUIT  
(CN902)  
(PAGE 24)

**A**  
TO MAIN CIRCUIT  
(CN903)  
(PAGE 24)

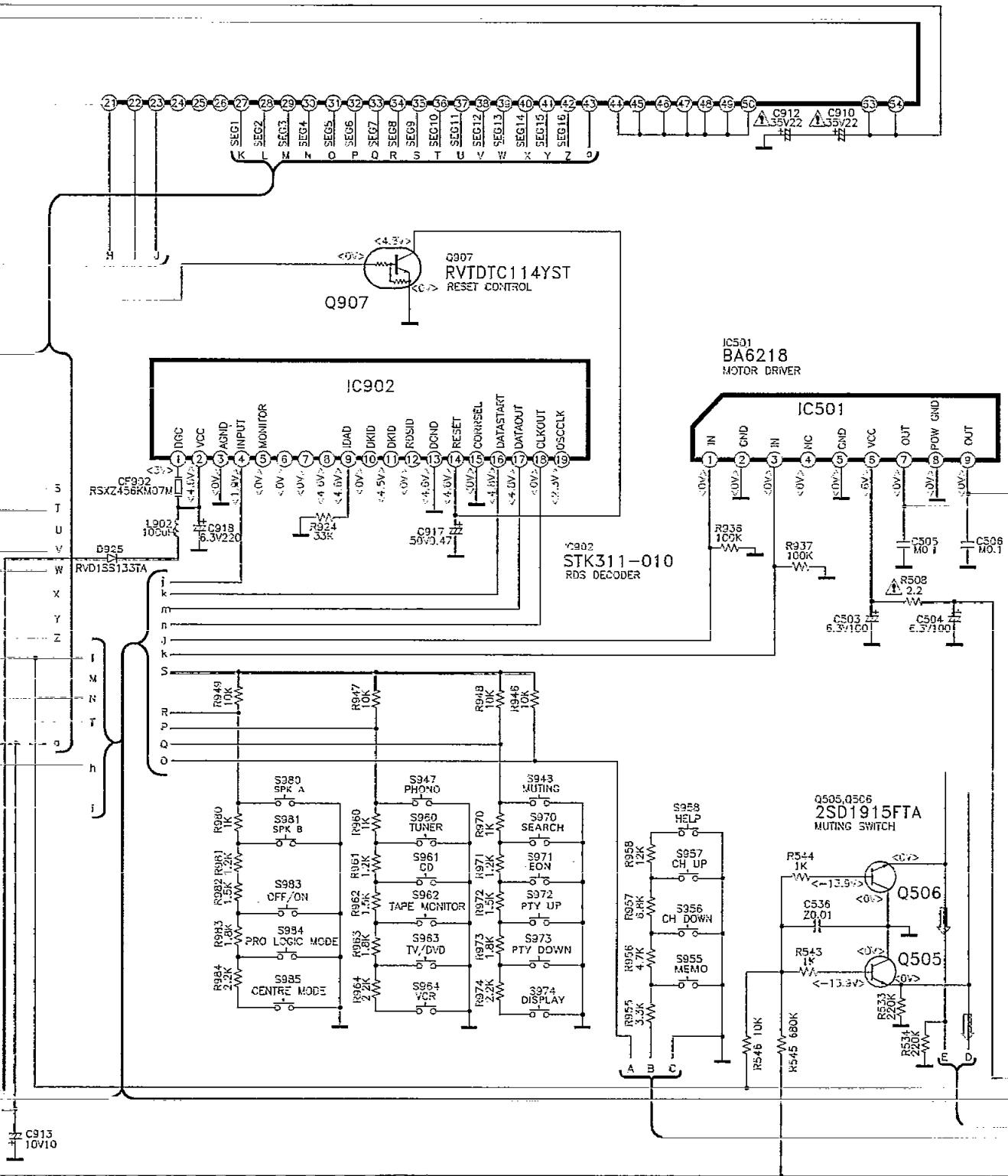

**C** MOTOR CIRCUIT

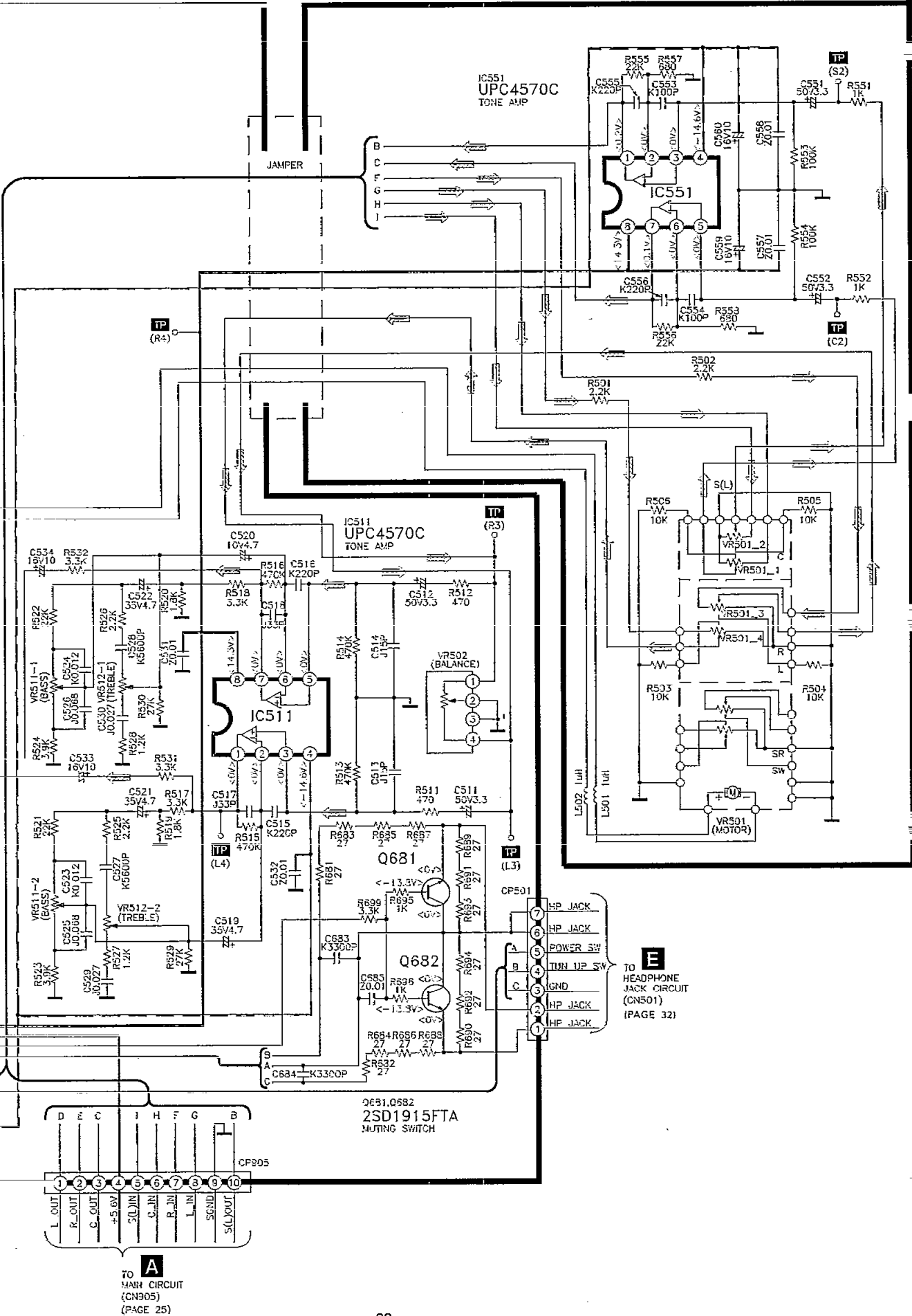

**A**  
TO MAIN CIRCUIT  
(CN905)  
(PAGE 25)

**E**  
TO HEADPHONE  
JACK CIRCUIT  
(CN501)  
(PAGE 32)

**A** MAIN CIRCUIT

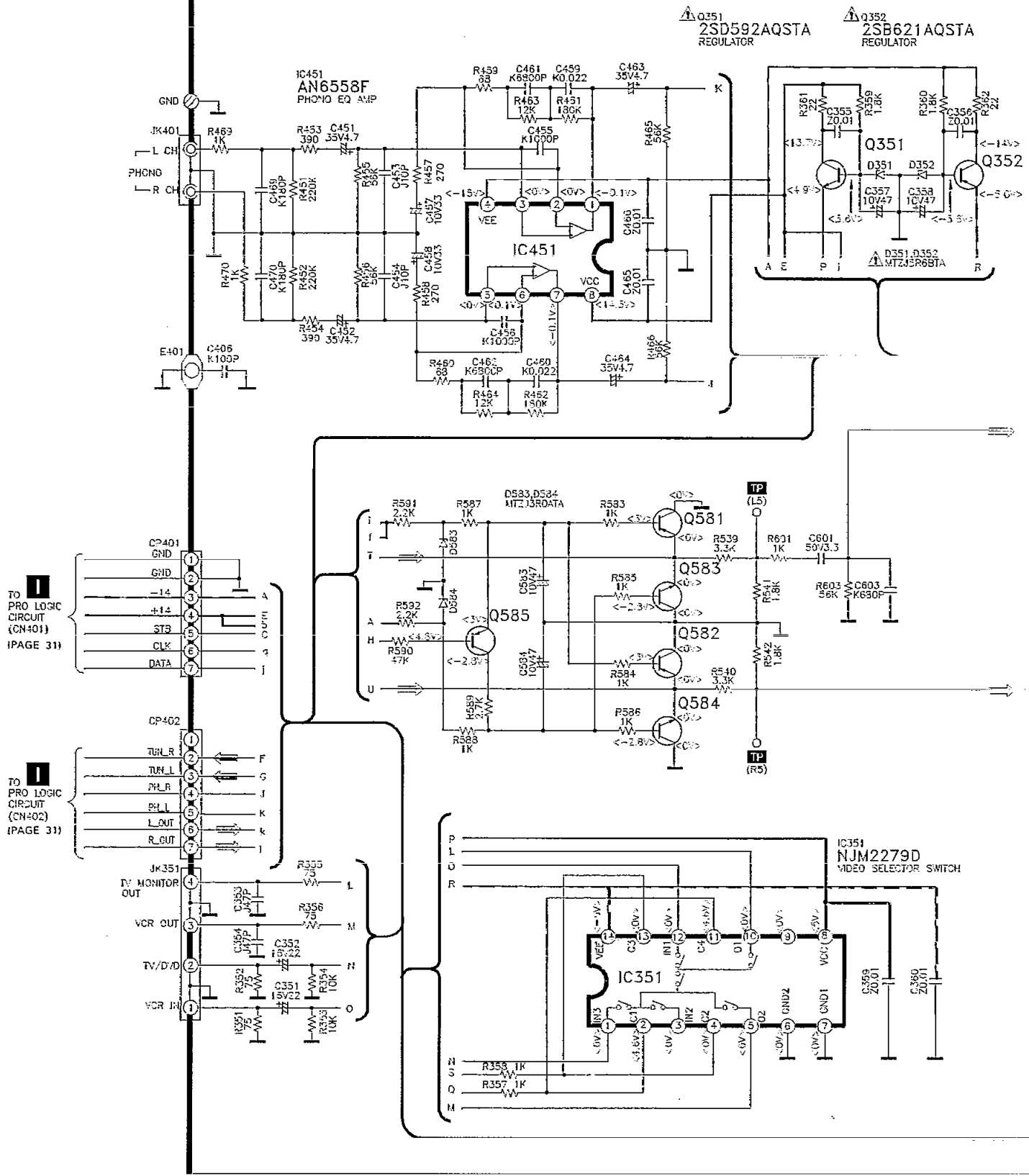





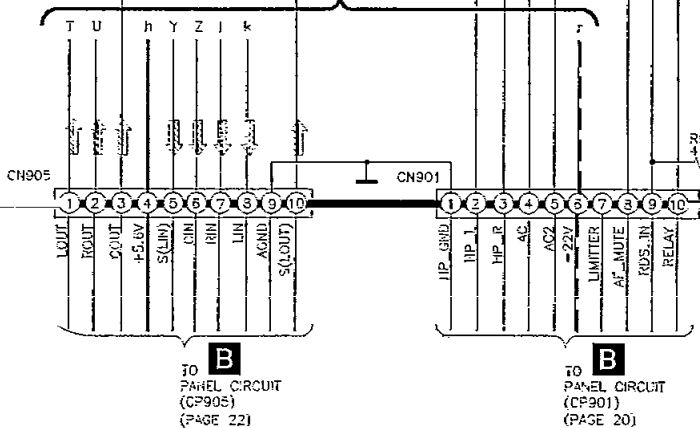
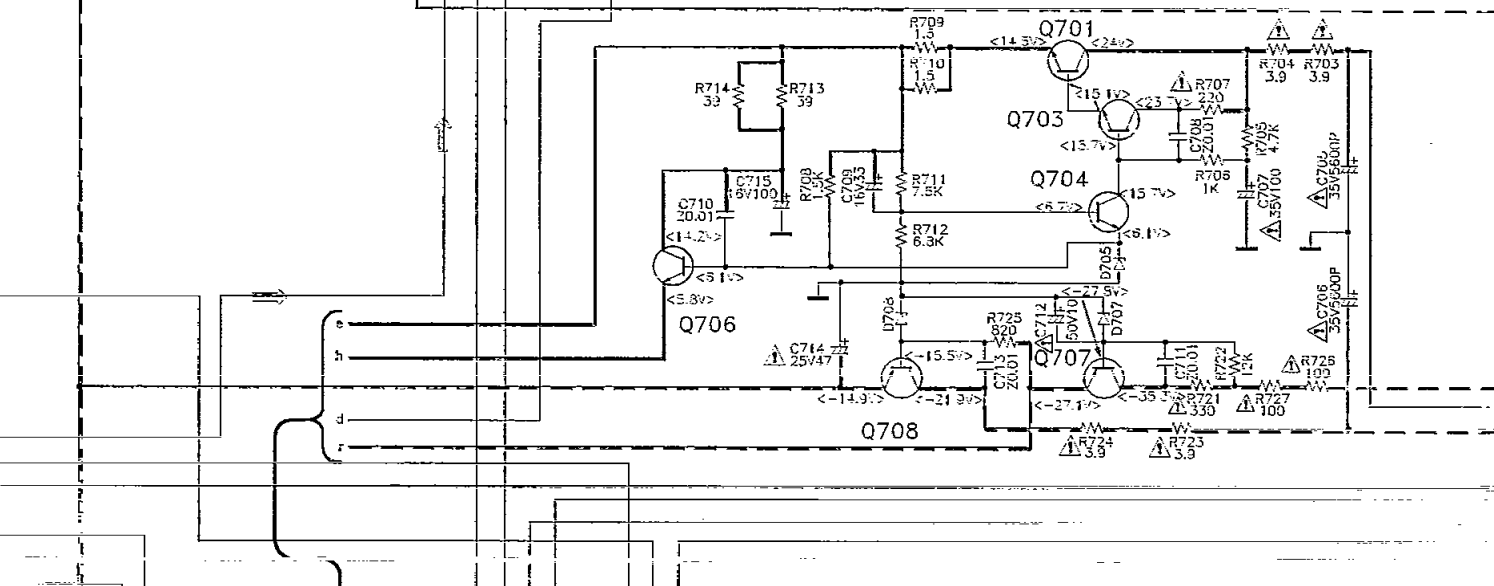
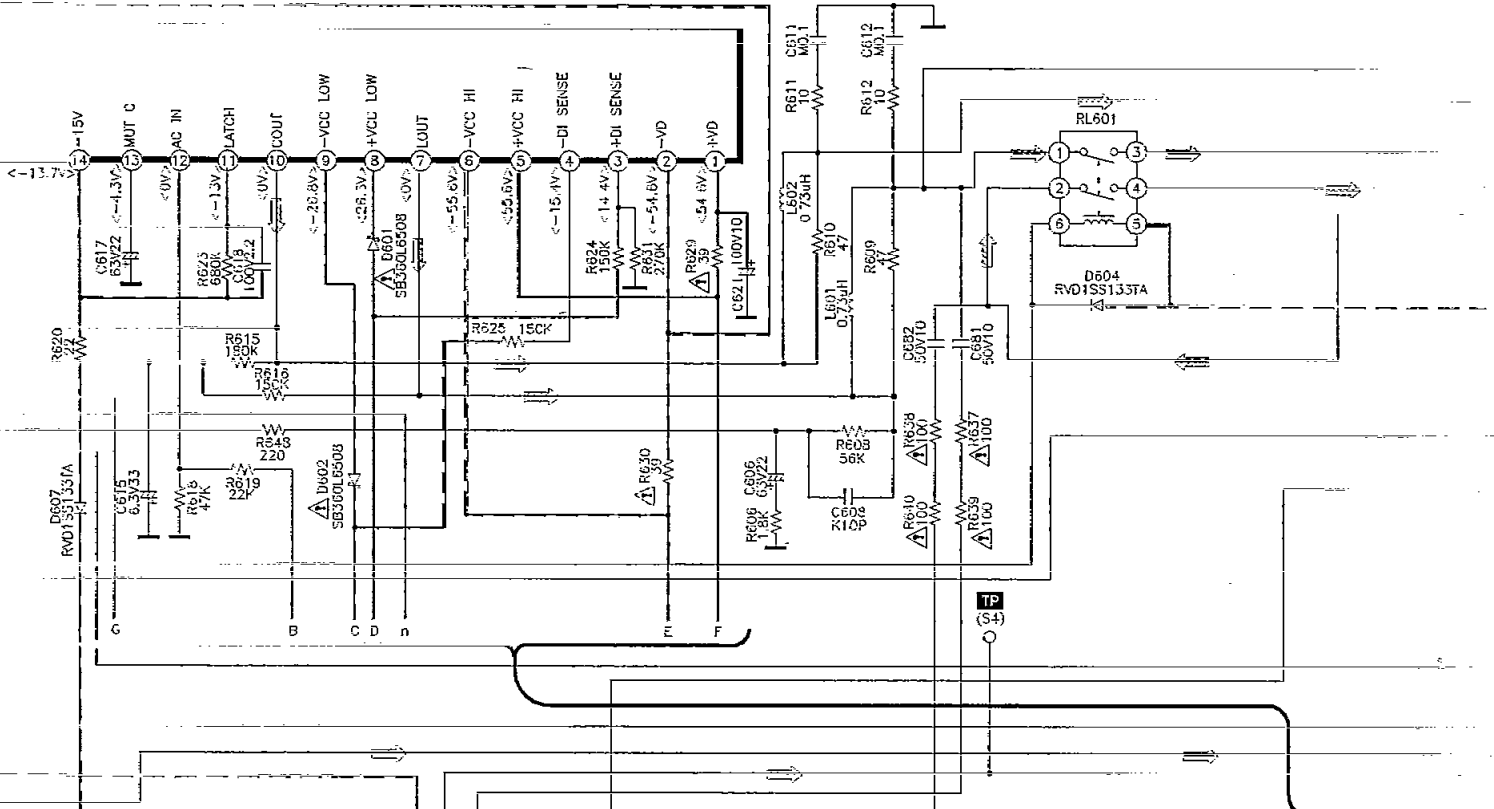

- Q701 2SD2374PQAU REGULATOR
- Q703, Q704 2SC1740SSTA REGULATOR
- Q706 2SB1548PQAU REGULATOR
- Q707 2SA1534AQRTA REGULATOR
- Q708 2SC3940AQSTA SWITCHING
- D705 MTZJ6R2BTA
- D707 MTZJ27DFTA
- D708 MTZJ15CTA

IC602  
RSN3305-P  
POWER AMP

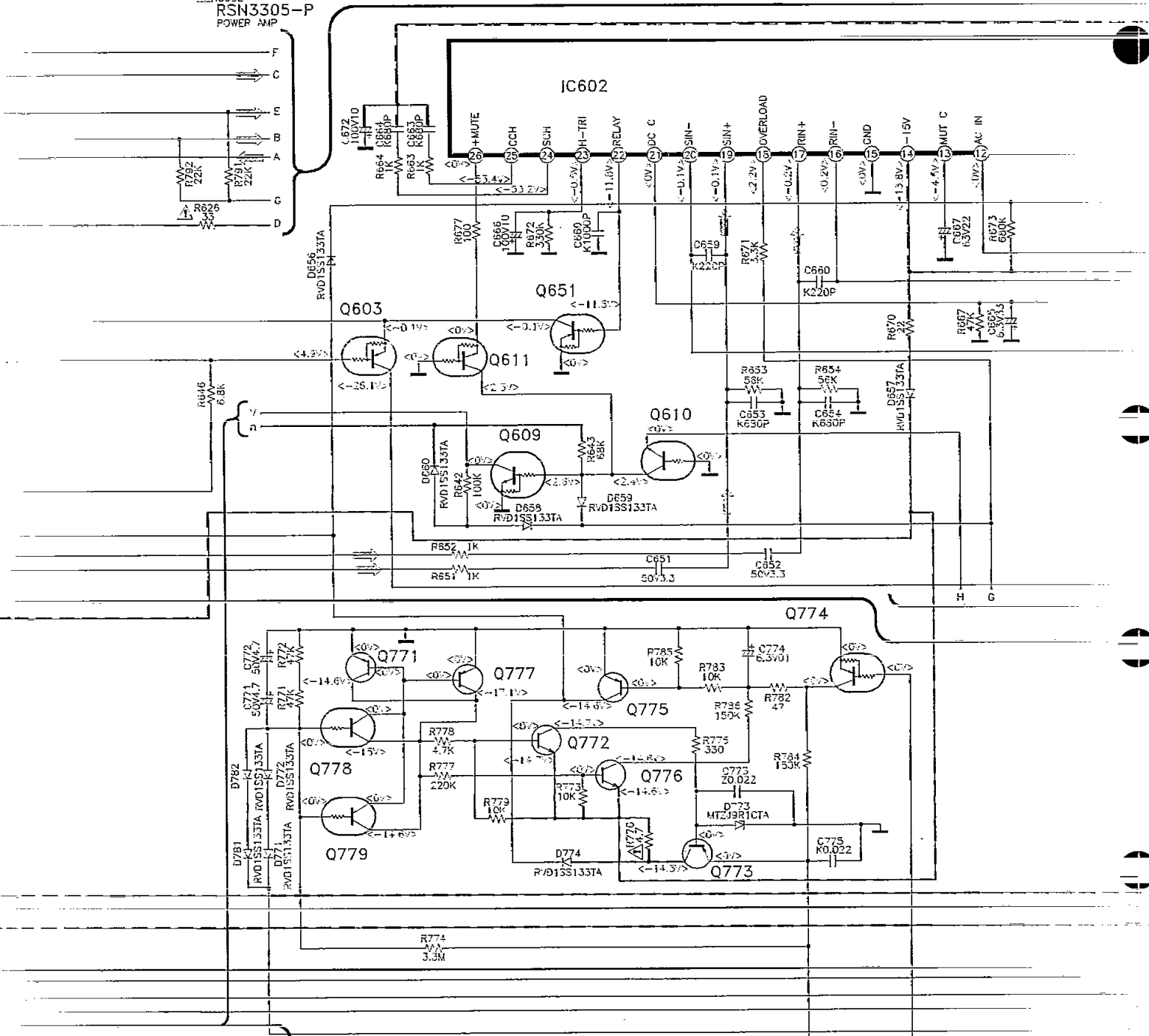

- |  |  |   |
|--|--|---|
| Q603<br>RVTDTA113ZST<br>RELAY DRIVER       | Q651<br>RVTDTA114EST<br>RELAY SWITCH   | Q774<br>RVTDTA114EST<br>FAN MOTOR DRIVE           |
| Q609<br>RVTDTA114EST<br>MUTING SWITCH      | Q772<br>2SC1740SSTA<br>FAN MOTOR DRIVE | Q771, Q775, Q777<br>2SA933SSTA<br>FAN MOTOR DRIVE |
| Q610, Q611<br>RVTDTA114TST<br>MUTING DRIVE | Q773<br>2SB621AQSTA<br>FAN MOTOR DRIVE | Q776, Q779<br>2SC1740SSTA<br>FAN MOTOR DRIVE      |
|  |  | Q775, Q778<br>RVTDTA114TST<br>FAN MOTOR DRIVE     |

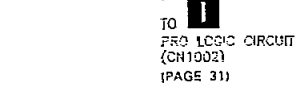

TO  
PRO LOGIC CIRCUIT  
(CH1002)  
(PAGE 31)

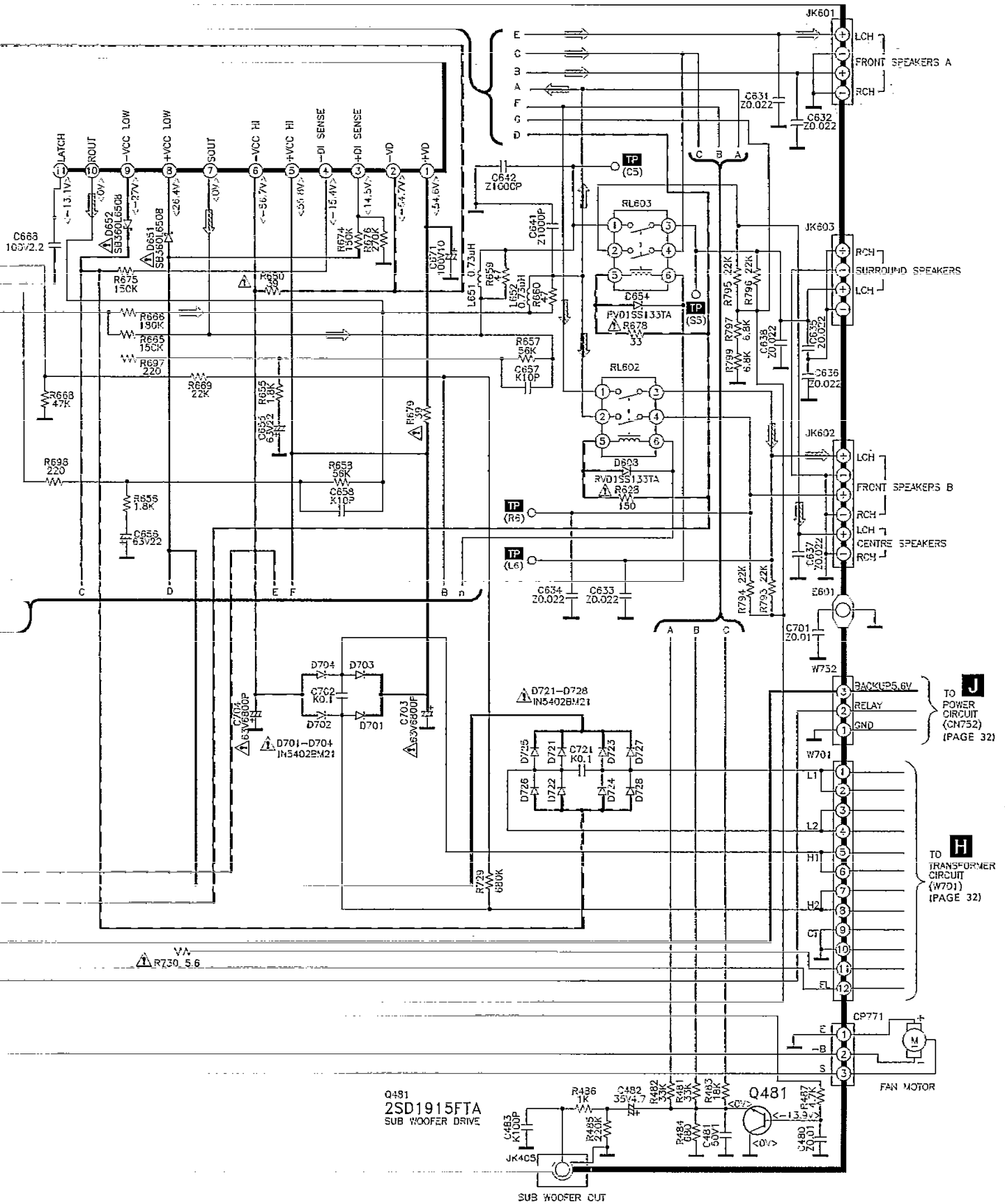

**F** TUNER CIRCUIT

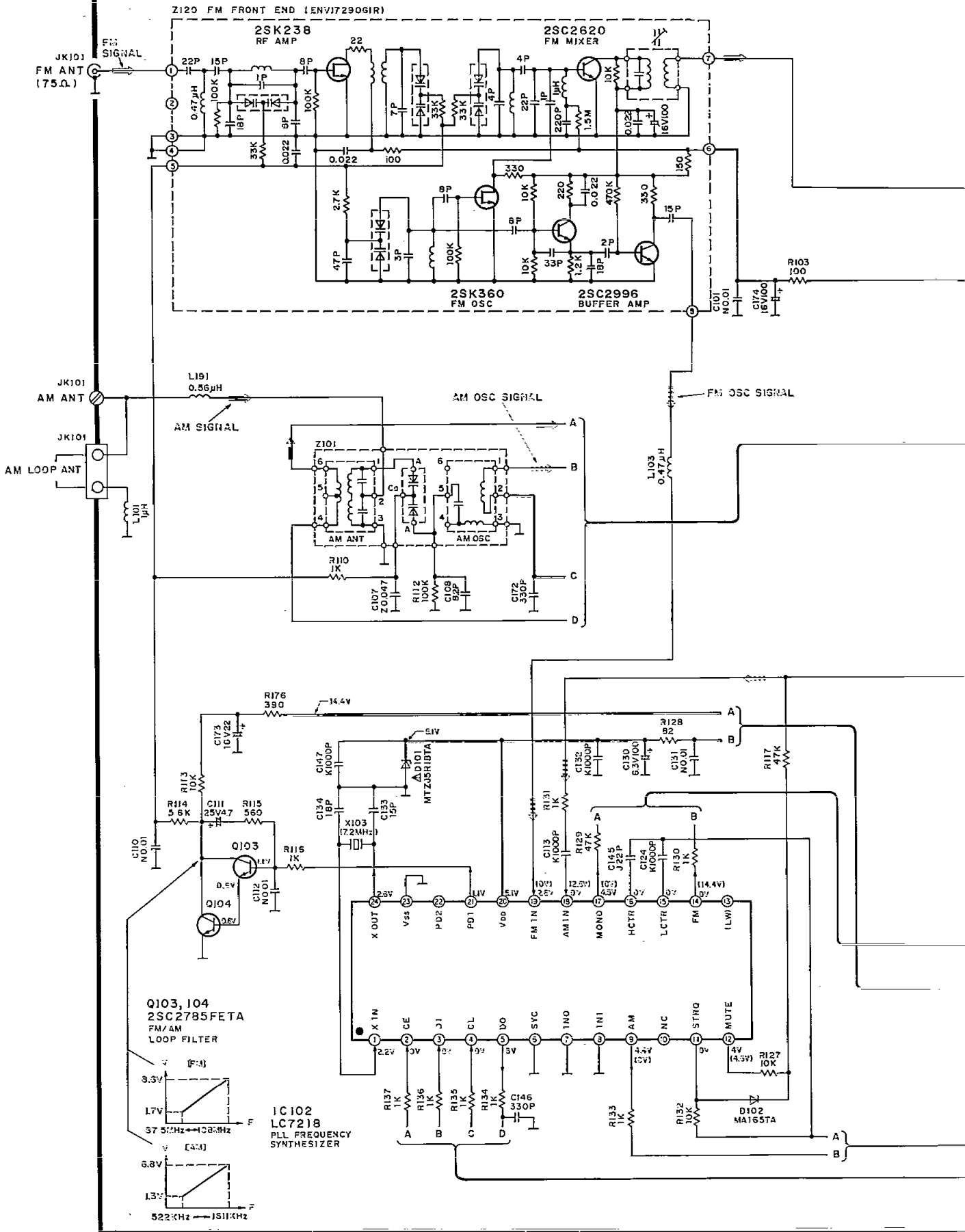

Q103, 104  
2SC2785FETA  
FM/AM  
LOOP FILTER

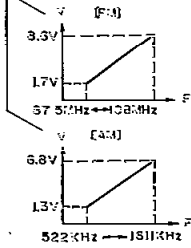

IC102  
LC7218  
PLL FREQUENCY  
SYNTHESIZER

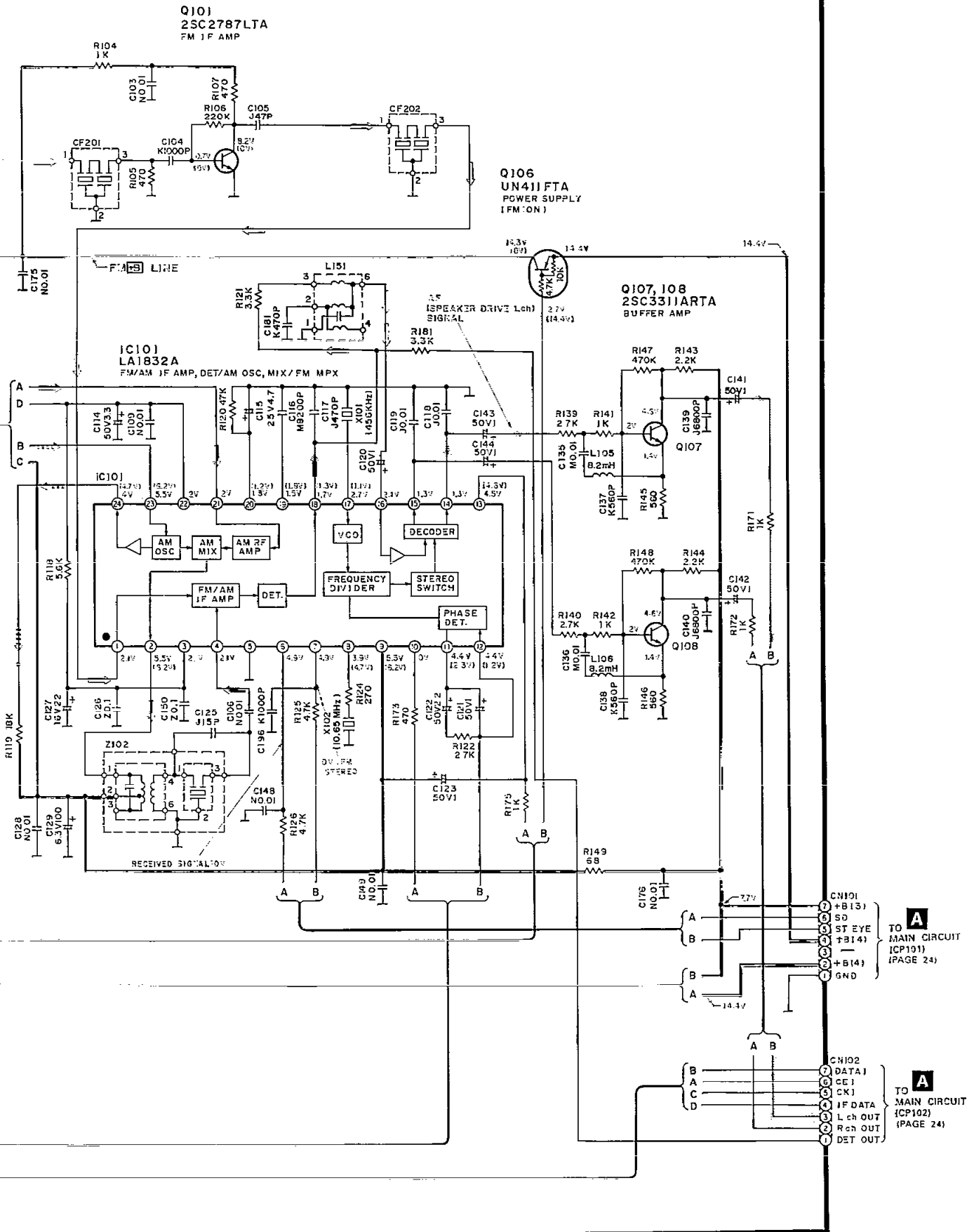

PRO LOGIC CIRCUIT

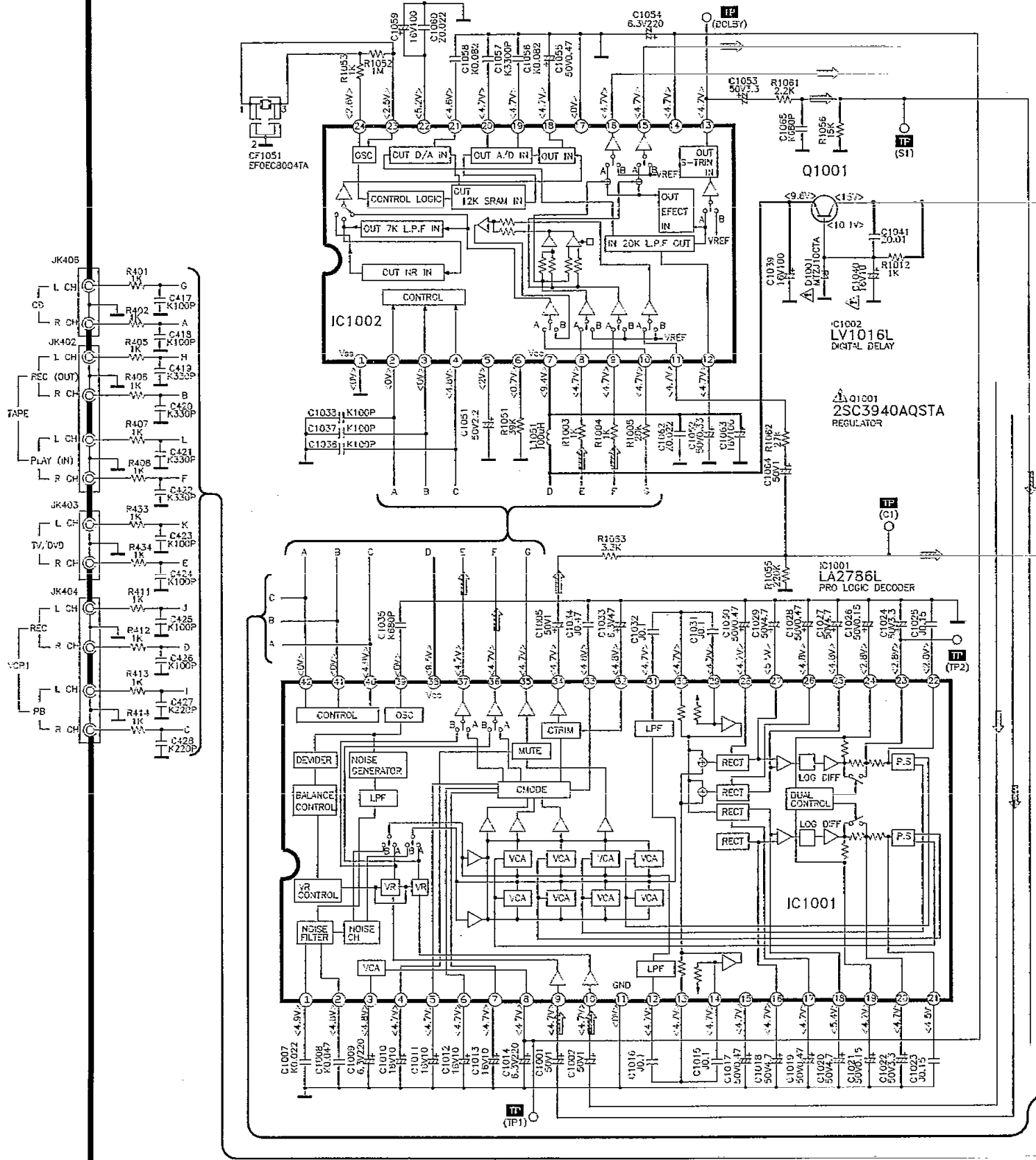

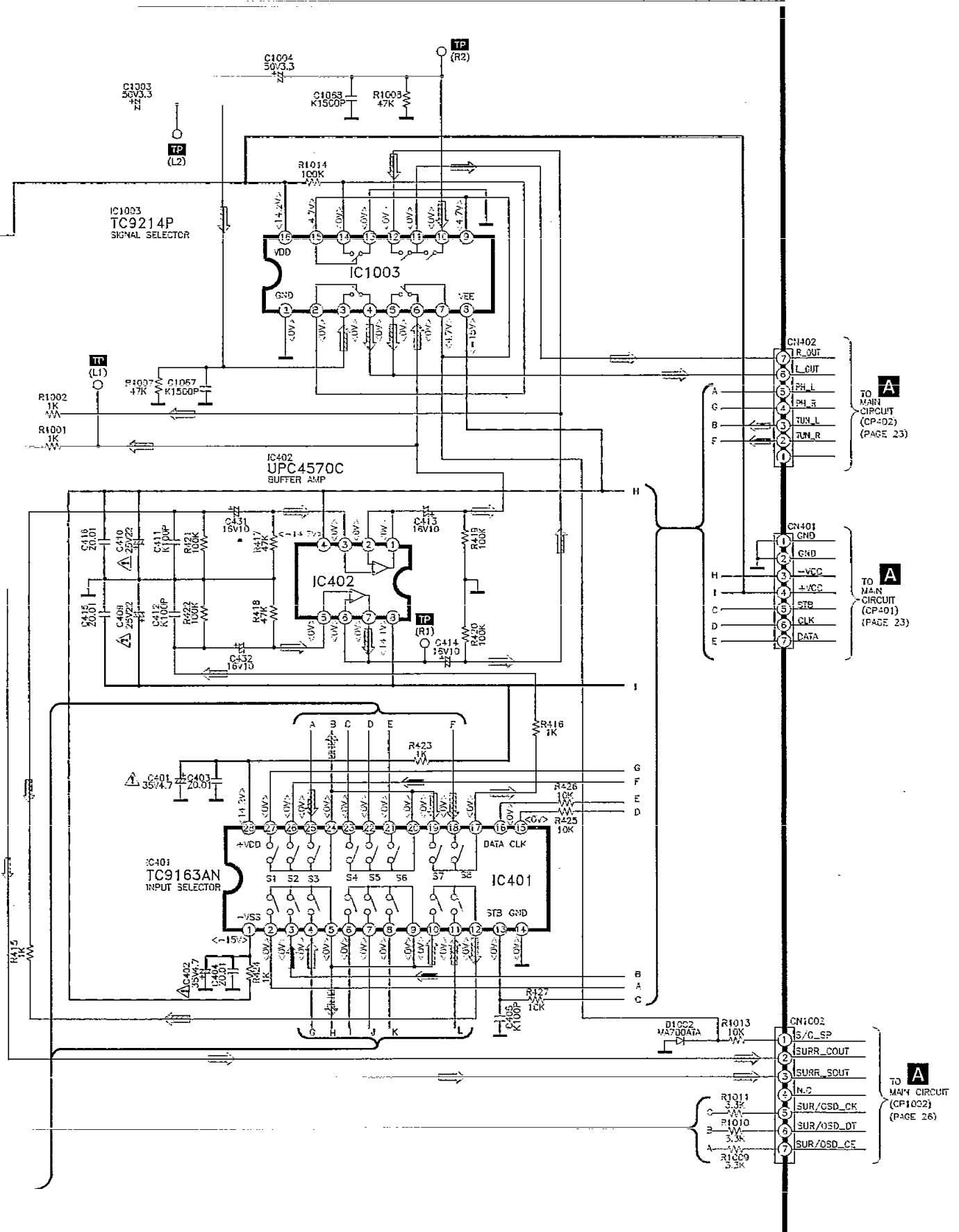

**J** POWER CIRCUIT

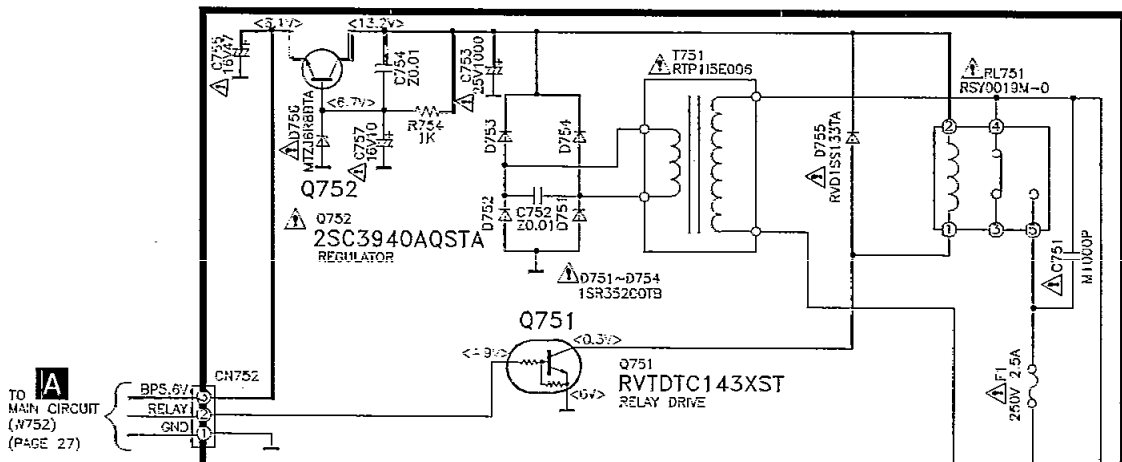

**H** TRANSFORMER CIRCUIT

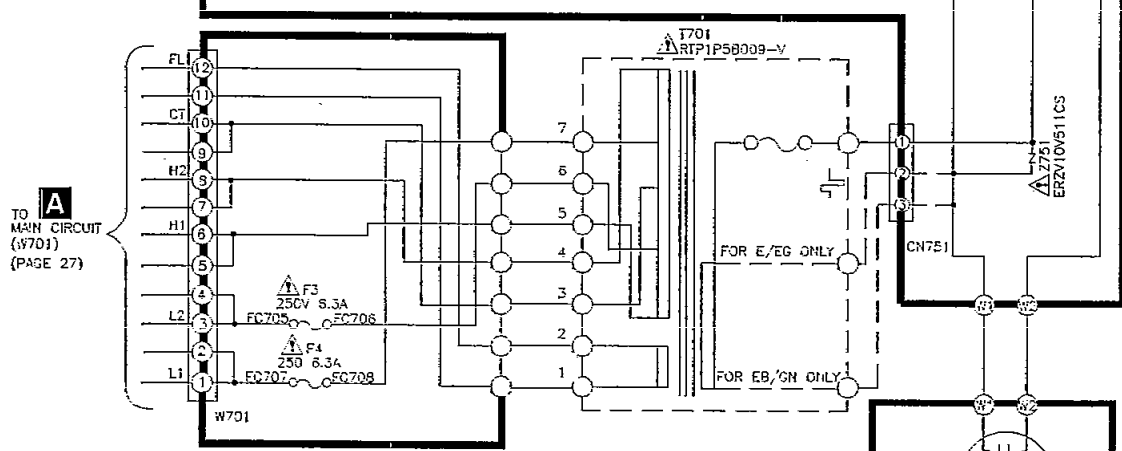

**K** AC INLET CIRCUIT

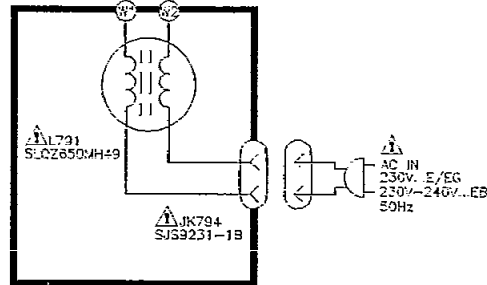

**E** HEADPHONE JACK CIRCUIT

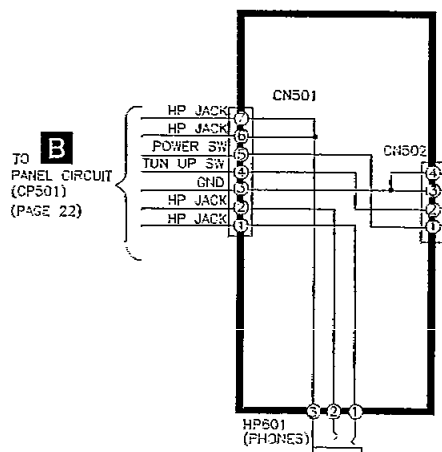

**D** POWER SWITCH CIRCUIT

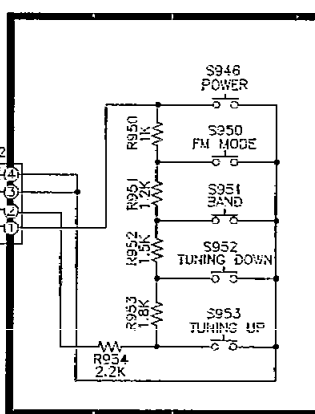



Printed Circuit Board

PRO LOGIC P.C.B. (REP2443G-P)...E/EG  
(REP2443H-P)...EB

CD

TAPE\_REC

TAPE\_P/B

TV

VCR1\_REC

VCR1\_P/B

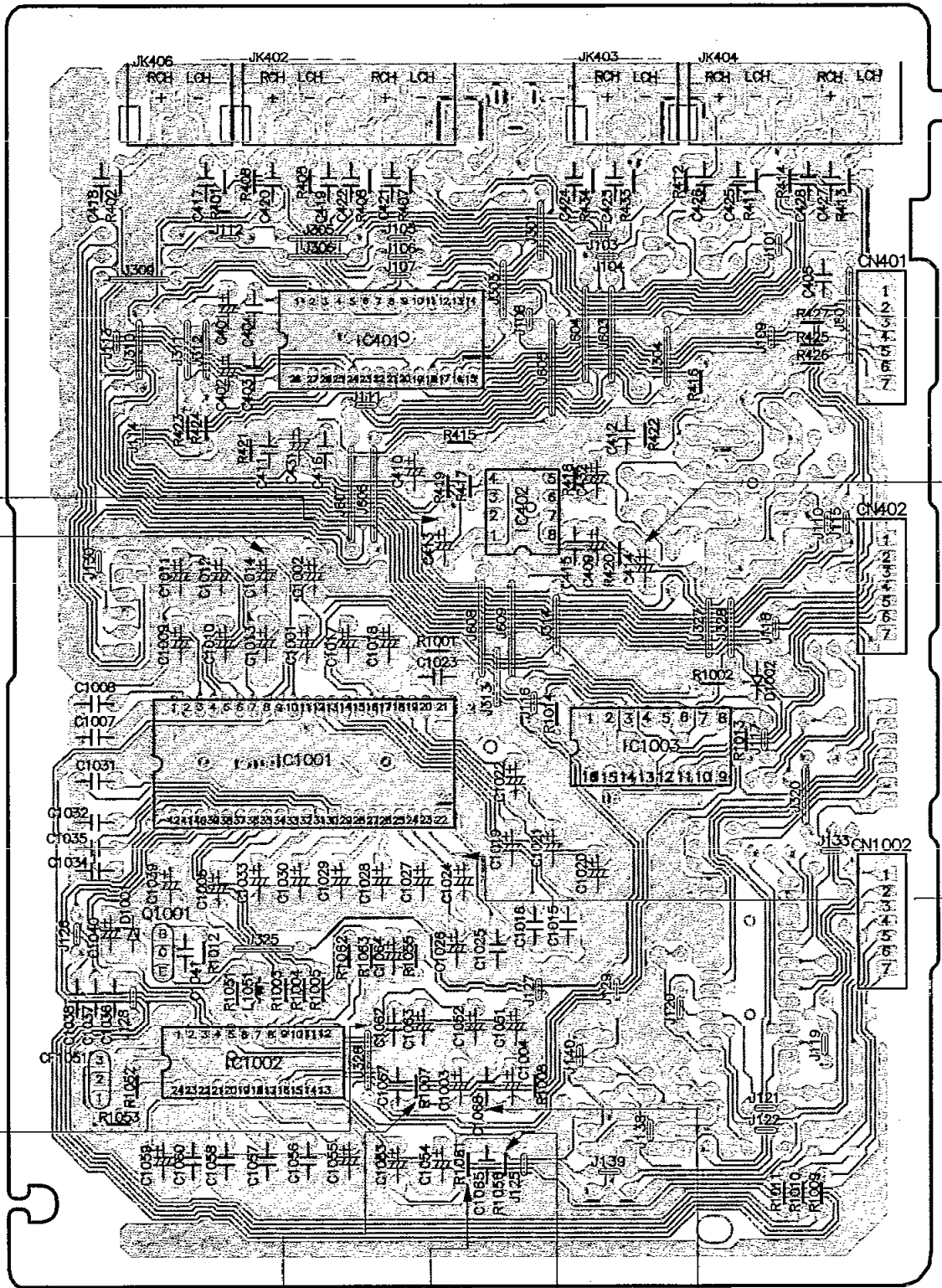

(L1) TP1

(R1) TP

(IC) TP

TP2

(L2) TP

(DOLBY) TP

(S1) TP

(R2) TP



SENSOR

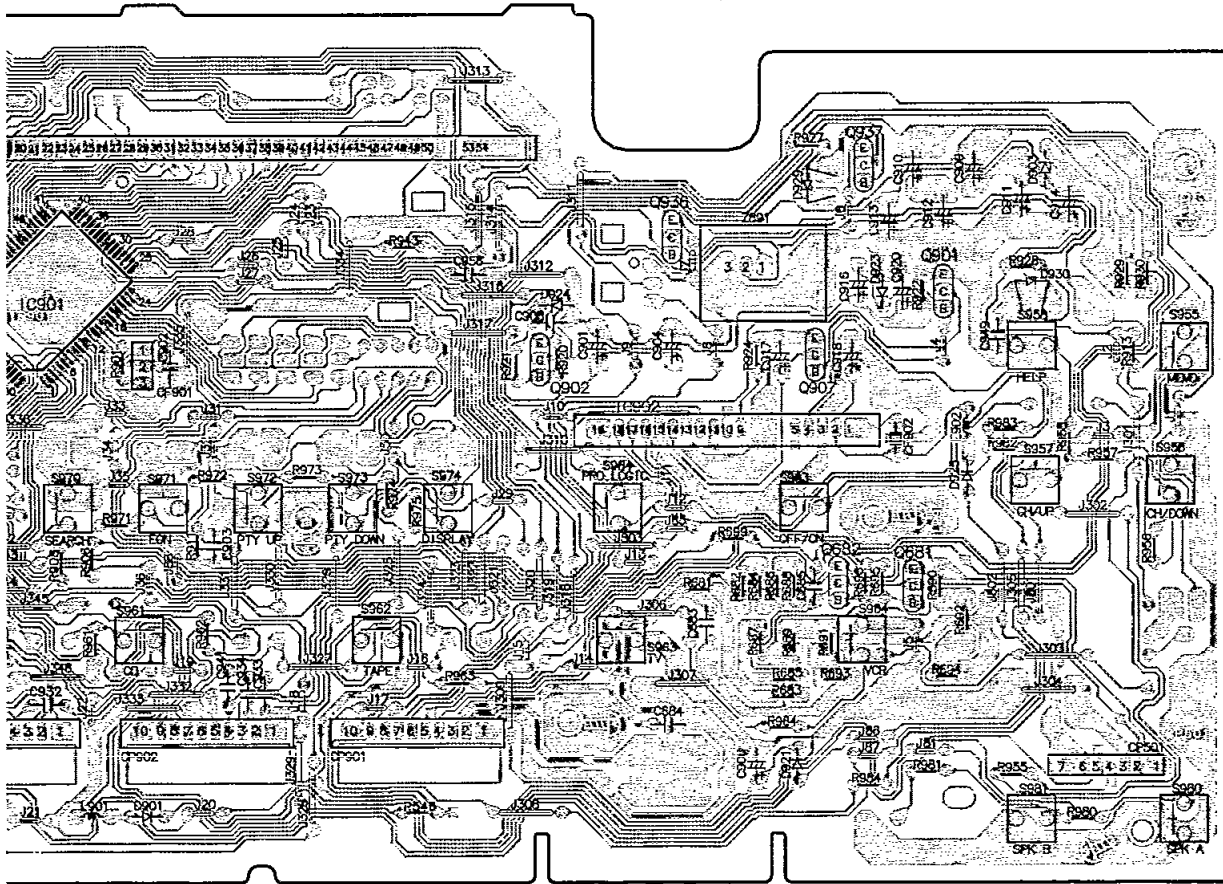

**D** OPERATION SWITCH P.C.B. (REP2442E-S)

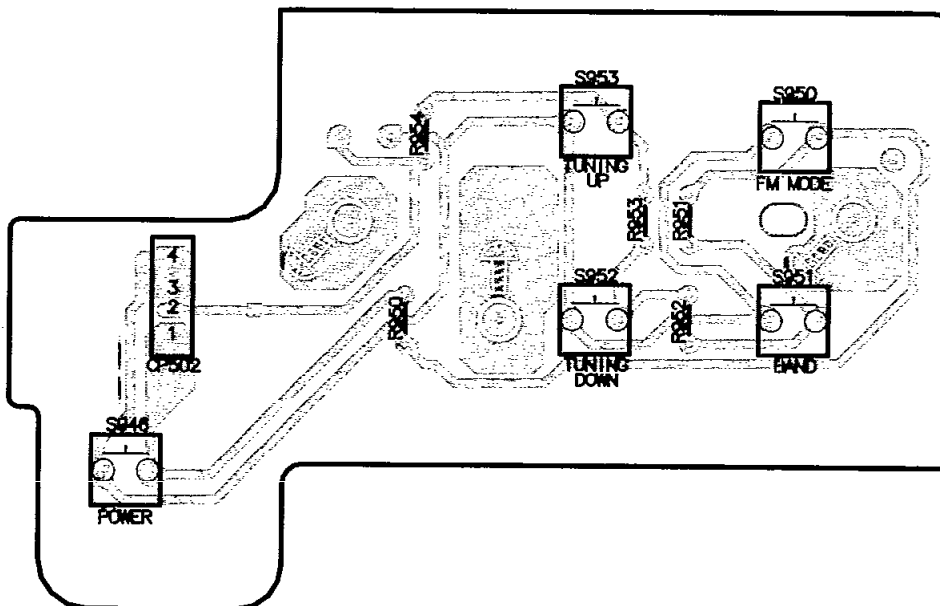

**A** MAIN P.C.B. (REP2441B-M)

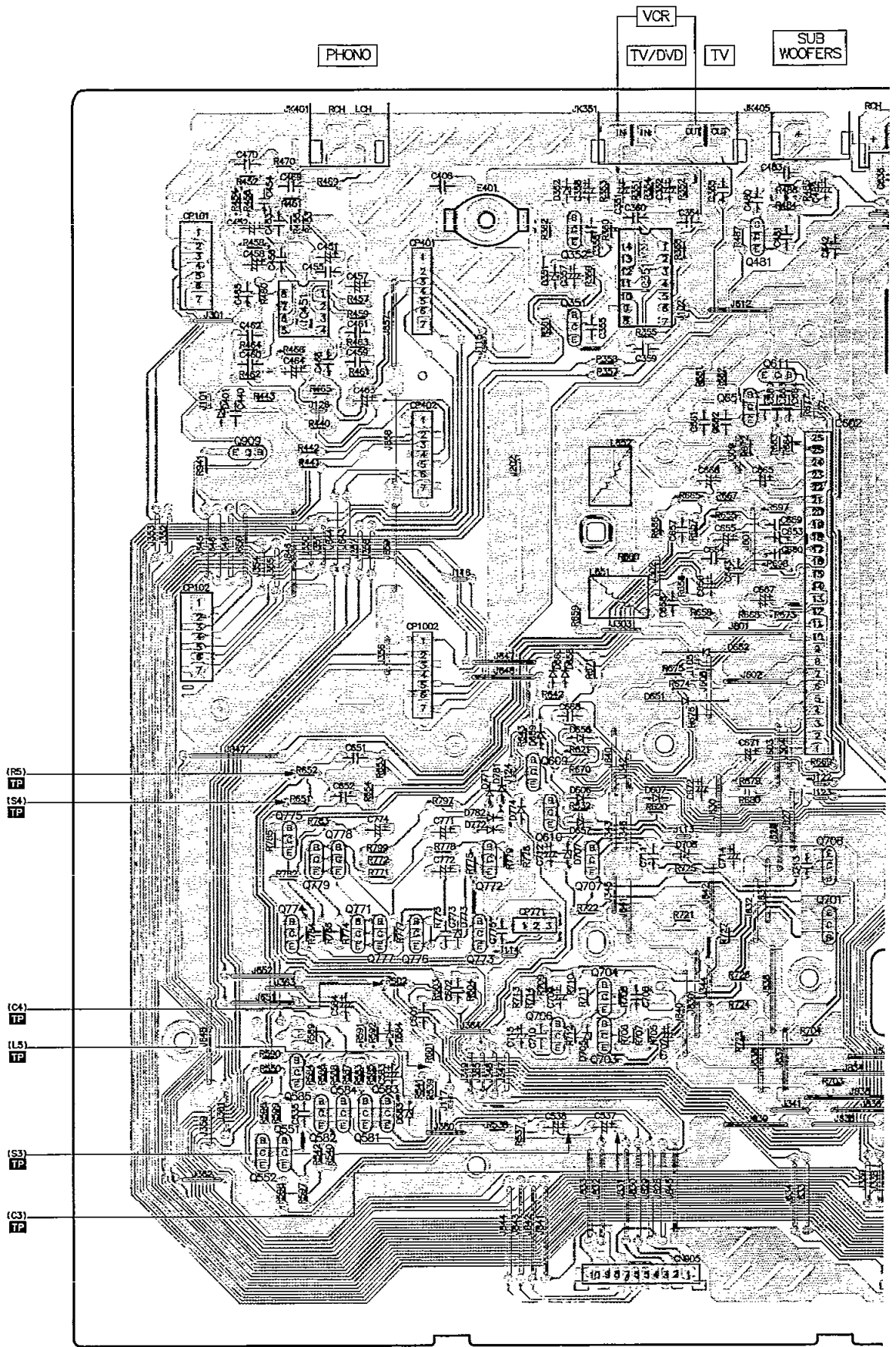



**F** TUNER P.C.B. (REP2158D-T) ...E/EB  
(REP2158A-T) ...EG

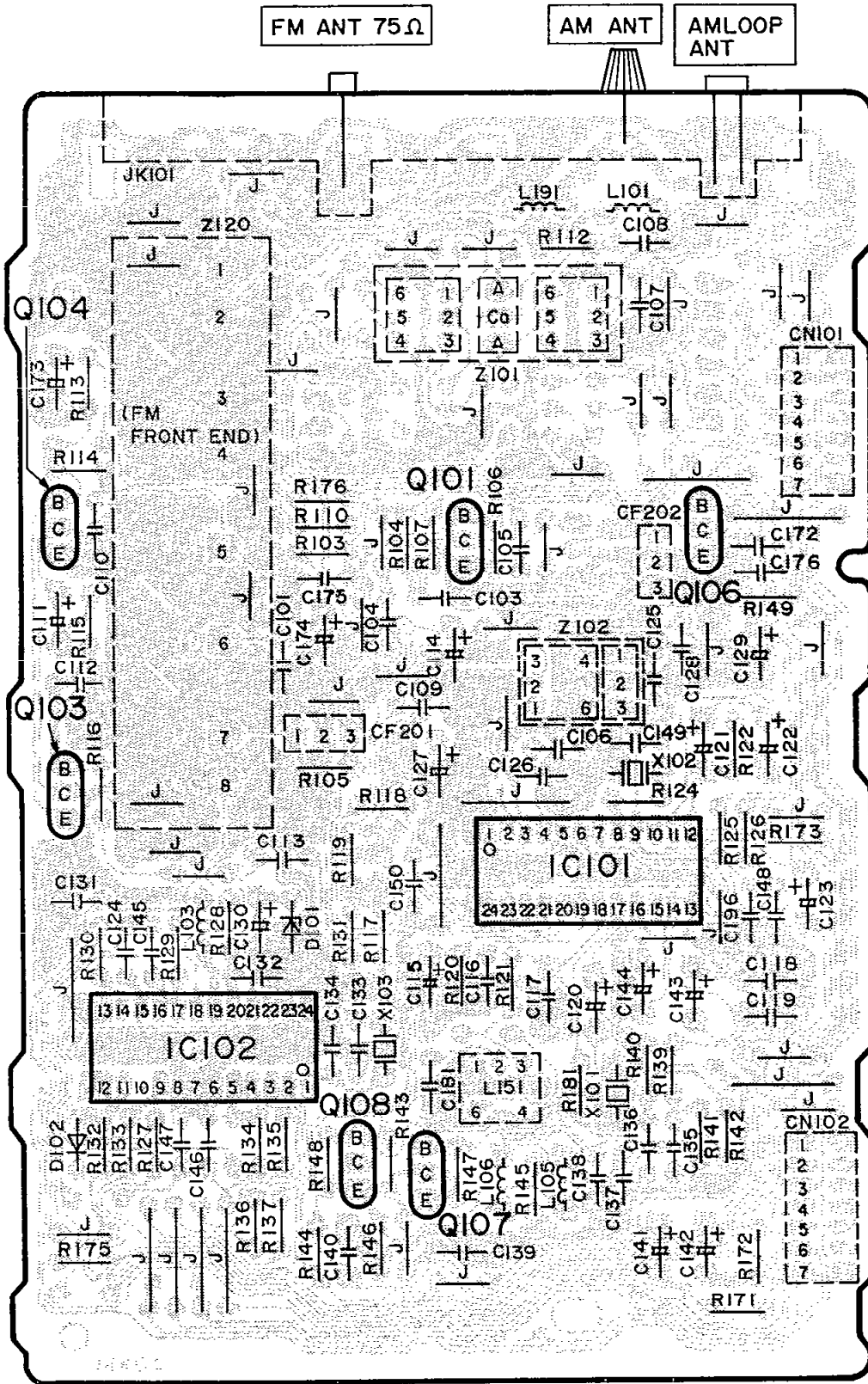

**H** TRANSFORMER P.C.B.  
(REP2441B-M)

**K** AC IN P.C.B.  
(REP2443G-P)...E/EG  
(REP2443H-P)...EB

AC IN ~  
230V  
...E/EG  
230V-240V  
...EB  
240V  
...GN  
50HZ

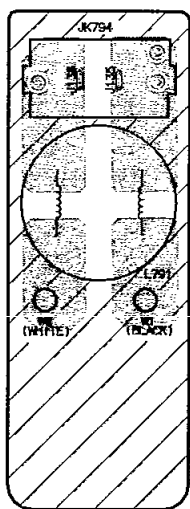

**CAUTION**  
**RISK OF ELECTRIC SHOCK**  
AC voltage line. Please do not touch this portion.

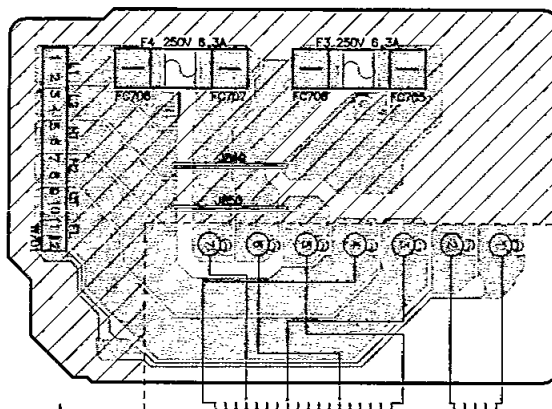

(POWER TRANSFORMER)

FOR E/EG ONLY

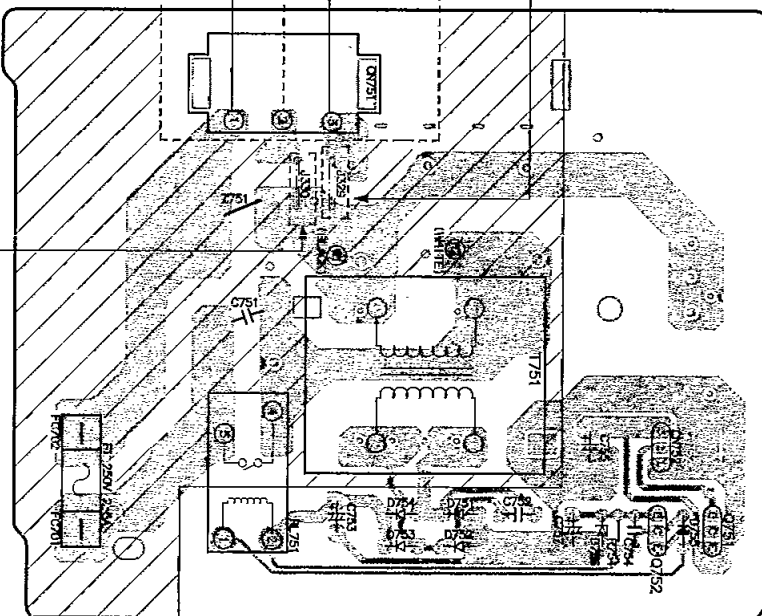

FOR EB/EN ONLY

**J** POWER P.C.B.  
(REP2443G-P)...E/EG  
(REP2443H-P)...EB

# Wiring Connection Diagram

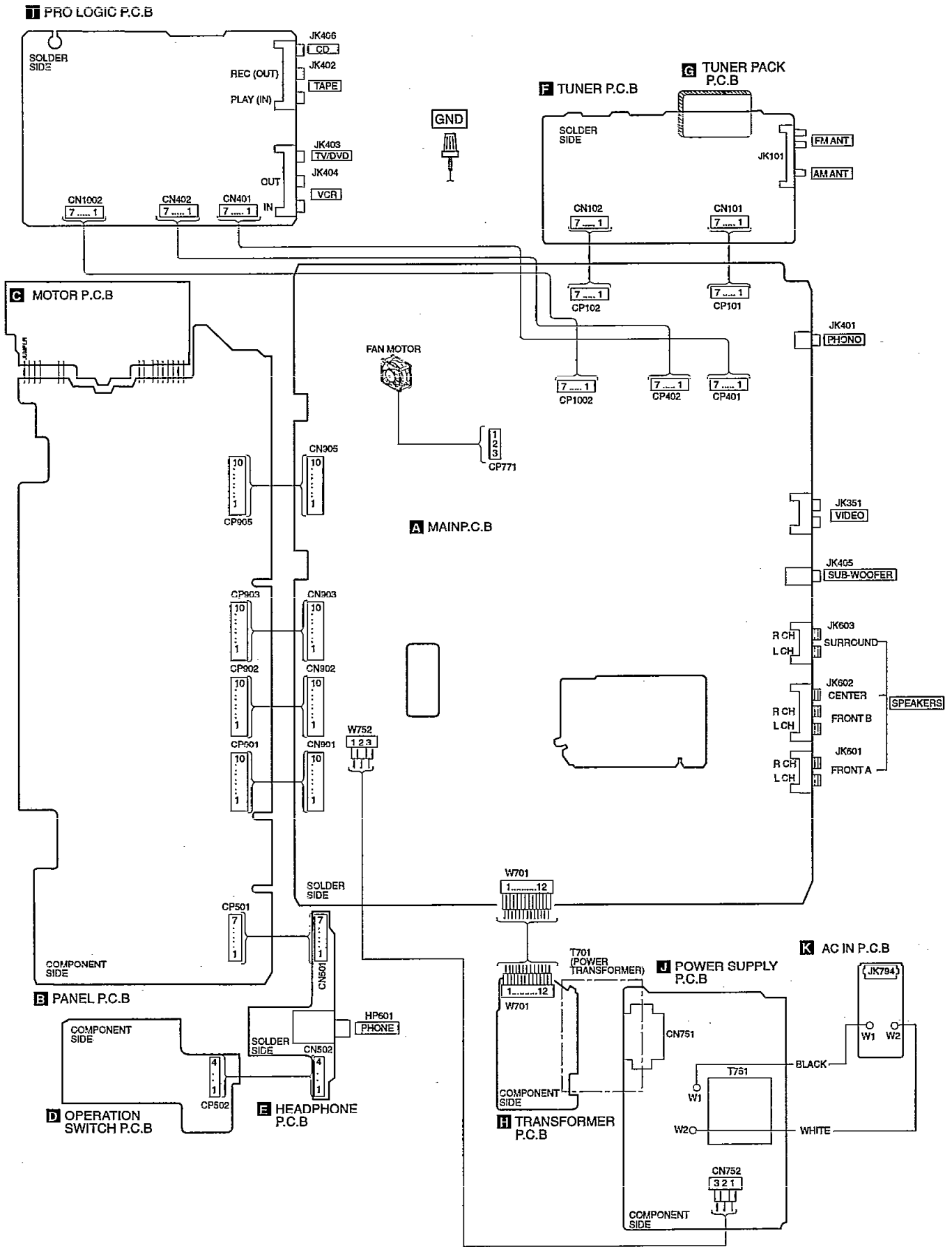





## Replacement Parts List

**Notes:** \* Important safety notice :

 Components identified by  $\Delta$  mark have special characteristics important for safety.

Furthermore, special parts which have purposes of fire-retardant (resistors), high-quality sound (capacitors), low-noise (resistors), etc. are used. When replacing any of components, be sure to use only manufacturer's specified parts shown in the parts list.

\* The parenthesized in the Remarks columns specify the areas. (Refer to the cover page for area.)

Parts without these indication can be used for all areas.

\* [M] in Remarks column indicates parts that are supplied by MESA.

\* Remote Control Unit : Supply period for three years from terminal of production.

\* The "(SF)" mark denotes the standard part.

Ref No.	Part No.	Part Name & Description	Remarks	Ref No.	Part No.	Part Name & Description	Remarks	Ref No.	Part No.	Part Name & Description	Remarks
		<b>CABINET AND CHASSIS</b>				<b>INTEGRATED CIRCUITS</b>		Q601	RVTDTA113ZST	TRANSISTOR	[M]
1	RKM0342-K	TOP CABINET	[M]	IC101	LA1832A	IC, IF/MPX	[M]	Q602	RVTDTA113ZST	TRANSISTOR	[M]
2	RGR0252C-A	REAR PANEL	[M](EG,E)	IC102	LC7218	IC, PLL	[M]	Q603	RVTDTA113ZST	TRANSISTOR	[M]
2	RGR0252C-B	REAR PANEL	[M](EB)	IC351	NJM2279D	IC,VIDEO SELECTOR SW	[M]	Q609	RVTDTA114EST	TRANSISTOR	[M]
3	RQW0243A-K	VOLUME KNOB	[M]	IC401	TC9163AN	IC, SELECTOR	[M]	Q610	RVTDTA114TST	TRANSISTOR	[M]
4	RKA0079-A	FOOT	[M]	IC402	UPC4570C	IC, TONE CONTROL	[M]	Q611	RVTDTA114TST	TRANSISTOR	[M]
5	RKQ0089-J	PCB HOLDER	[M]	IC451	AN6558F	IC, OP AMP	[M]	Q651	RVTDTA114EST	TRANSISTOR	[M]
6	RMC0158-S	TRANSISTOR HOLDER	[M]	IC501	BA6218	IC, MOTOR DRIVER	[M]	Q651	2SD1915FTA	TRANSISTOR	[M]
7	RMK0350	BOTTOM CHASSIS	[M]	IC511	UPC4570C	IC, TONE CONTROL	[M]	Q682	2SD1915FTA	TRANSISTOR	[M]
8	RMN0372	FL HOLDER	[M]	IC551	UPC4570C	IC, TONE CONTROL	[M]	Q701	2SD2374PQAU	TRANSISTOR	[M] $\Delta$
9	SNE2123	EARTH TERMINAL	[M]	IC601	RSN3305-P	IC, HIC	[M] $\Delta$	Q703	2SC1740SSTA	TRANSISTOR	[M] $\Delta$
10	RXX0182	HEAT SINK UNIT	[M]	IC602	RSN3305-P	IC, HIC	[M] $\Delta$	Q704	2SC1740SSTA	TRANSISTOR	[M] $\Delta$
11	RGU1493-K	SELECTOR BUTTON	[M]	IC901	M38B53M4053F	IC, MICOM	[M]	Q706	2SC3940AQSTA	TRANSISTOR	[M]
12	RGU1350D-K	MODE BUTTON	[M]	IC902	STK311-010	IC, RDS DECODER	[M]	Q707	2SA1534AQRTA	TRANSISTOR	[M] $\Delta$
13	RGW0216-K	TONE KNOB	[M]	IC1001	LA2786L	IC, DPL	[M]	Q708	2SB1548PQAU	TRANSISTOR	[M] $\Delta$
14	RHN90001	M9 NUT	[M]	IC1002	LV1016L	IC, SURR DECODER	[M]	Q751	RVTDTA143XST	TRANSISTOR	[M]
15	RMN0450	LED SUPPORT	[M]	IC1003	TC9214P	IC, SELECTOR	[M]	Q752	2SC3940AQSTA	TRANSISTOR	[M] $\Delta$
16	RFKGEX510EBK	FRONT PANEL ASS'Y	[M]					Q771	2SA933SSTA	TRANSISTOR	[M]
16-1	RKW0493B-Q	FL WINDOW	[M]					Q772	2SC1740SSTA	TRANSISTOR	[M]
17	SNE2129-1	SCREW (CABINET)	[M]					Q773	2SB621AQSTA	TRANSISTOR	[M]
18	XTBS3+8JFZ1	SCREW	[M]					Q774	RVTDTA114EST	TRANSISTOR	[M]
19	XTB3+20JFZ	SCREW	[M]	Q101	2SC2787LTA	TRANSISTOR	[M]	Q775	2SA933SSTA	TRANSISTOR	[M]
20	XTB3+8FFZ	SCREW	[M]	Q103	2SC2785FETA	TRANSISTOR	[M]	Q776	2SC1740SSTA	TRANSISTOR	[M]
22	XTW3+15T	SCREW	[M]	Q104	2SC2785FETA	TRANSISTOR	[M]	Q777	2SA933SSTA	TRANSISTOR	[M]
23	RHD26016	SCREW	[M]	Q106	RVTDTA143XST	TRANSISTOR	[M]	Q778	RVTDTA114TST	TRANSISTOR	[M]
24	XTBS26+10J	SCREW (FRONT)	[M]	Q107	2SC3311ARTA	TRANSISTOR	[M]	Q779	RVTDTA114TST	TRANSISTOR	[M]
25	RMN0313	LED SUPPORT	[M]	Q108	2SC3311ARTA	TRANSISTOR	[M]	Q901	RVTDTA114YST	TRANSISTOR	[M]
27	XTB3+30J	SCREW	[M]	Q351	2SD592AQSTA	TRANSISTOR	[M] $\Delta$	Q902	2SA933SSTA	TRANSISTOR	[M]
28	REM0069	FAN UNIT	[M]	Q352	2SB621AQSTA	TRANSISTOR	[M] $\Delta$	Q907	RVTDTA114YST	TRANSISTOR	[M]
29	RGU1492-K	SLEEP/MUTE BUTTON	[M]	Q481	2SD1915FTA	TRANSISTOR	[M]	Q909	2SC1740SSTA	TRANSISTOR	[M]
31	RGU1352K-K	DOLBY BUTTON	[M]	Q505	2SD1915FTA	TRANSISTOR	[M]	Q936	RVTDTA114YST	TRANSISTOR	[M]
32	RGU1398-Q	HELP BUTTON	[M]	Q506	2SD1915FTA	TRANSISTOR	[M]	Q937	RVTDTA114YST	TRANSISTOR	[M]
33	RMQ0709	TUNER PCB BRACKET	[M]	Q551	2SD1915FTA	TRANSISTOR	[M]	Q1001	2SC3940AQSTA	TRANSISTOR	[M] $\Delta$
35	SJS9231A	A/C INLET COVER	[M]	Q552	2SD1915FTA	TRANSISTOR	[M]				
				Q581	2SA933SSTA	TRANSISTOR	[M]			<b>DIODES</b>	
				Q582	2SA933SSTA	TRANSISTOR	[M]	D101	MTZJ5R1BTA	DIODE	[M]
				Q583	2SC1740SSTA	TRANSISTOR	[M]	D102	MA165TA	DIODE	[M]
				Q584	2SC1740SSTA	TRANSISTOR	[M]	D351	MTZJ5R6BTA	DIODE	[M] $\Delta$
				Q585	2SA933SSTA	TRANSISTOR	[M]				

Ref No.	Part No.	Part Name & Description	Remarks	Ref No.	Part No.	Part Name & Description	Remarks	Ref No.	Part No.	Part Name & Description	Remarks
D332	MTZJ5R6BTA	DIODE	[M]▲	D907	MA167ATA	DIODE	[M]			CONNECTORS	
D401	MTZJ7R5CTA	DIODE	[M]	D921	RVD1SS133TA	DIODE	[M]				
D583	MTZJ3R0ATA	DIODE	[M]	D923	RVD1SS133TA	DIODE	[M]	CN101	RJU057W007	7P CONNECTOR	[M]
D584	MTZJ3R0ATA	DIODE	[M]	D924	MTZJ3R9ATA	DIODE	[M]	CN102	RJU057W007	7P CONNECTOR	[M]
D601	SB360L6508	DIODE	[M]▲	D925	MA723TA	DIODE	[M]	CN401	RJU100W07	7P CONNECTOR	[M]
D602	SB360L6508	DIODE	[M]▲	D929	LN846RP	DIODE	[M]	CN402	RJU100W07	7P CONNECTOR	[M]
D604	RVD1SS133TA	DIODE	[M]	D930	SLR342DC	DIODE	[M]	CN501	RJU100W07	7P CONNECTOR	[M]
D605	MTZJ6R2BTA	DIODE	[M]	D1001	MTZJ10CTA	DIODE	[M]	CN502	RJU100W04	4P CONNECTOR	[M]
D606	RVD1SS133TA	DIODE	[M]	D1002	MA700ATA	DIODE	[M]	CN751	SJS305-1	3P CONNECTOR	[M]
D607	RVD1SS133TA	DIODE	[M]					CN752	RJS1A6603T1	3 PIN TAPING CONNECT	[M]
D608	RVD1SS133TA	DIODE	[M]			VARIABLE RESISTORS		CN901	RJU003K010M1	10P B/B CONNECTOR	[M]
D651	SB360L6508	DIODE	[M]▲					CN902	RJU003K010M1	10P B/B CONNECTOR	[M]
D652	SB360L6508	DIODE	[M]▲	VR501	EUWMRH026B15	VR, MOTOR	[M]	CN903	RJU003K010M1	10P B/B CONNECTOR	[M]
D654	RVD1SS133TA	DIODE	[M]	VR502	EWC0YAF15G15	VR, BALANCE CONTROL	[M]	CN905	RJU003K010M1	10P B/B CONNECTOR	[M]
D656	RVD1SS133TA	DIODE	[M]	VR511	EWC1XA020C15	VR, TONE CONTROL	[M]	CN1002	RJU100W07	7P CONNECTOR	[M]
D657	RVD1SS133TA	DIODE	[M]	VR512	EWC1XA020C15	VR, TONE CONTROL	[M]	CP101	RJT057W007-1	7P CONNECTOR	[M]
D658	RVD1SS133TA	DIODE	[M]					CP102	RJT057W007-1	7P CONNECTOR	[M]
D659	RVD1SS133TA	DIODE	[M]			SWITCHES		CP401	RJT100W07	7P CONNECTOR	[M]
D660	RVD1SS133TA	DIODE	[M]					CP402	RJT100W07	7P CONNECTOR	[M]
D701	1N5402BM21	DIODE	[M]▲	S946	EVQ21405R	SW, POWER	[M]	CP501	RJT100W07	7P CONNECTOR	[M]
D702	1N5402BM21	DIODE	[M]▲	S947	EVQ21405R	SW, PHONO	[M]	CP502	RJT100W04	4P CONNECTOR	[M]
D703	1N5402BM21	DIODE	[M]▲	S948	EVQ21405R	SW, MUTING	[M]	CP771	RJP3G4YA	CONNECTOR	[M]
D704	1N5402BM21	DIODE	[M]▲	S950	EVQ21405R	SW, FM MODE	[M]	CP901	RJT003K010M1	10P CONNECTOR	[M]
D705	MTZJ6R2BTA	DIODE	[M]▲	S951	EVQ21405R	SW, BAND	[M]	CP902	RJT003K010M1	10P CONNECTOR	[M]
D707	MTZJ27DTA	DIODE	[M]▲	S952	EVQ21405R	SW, TUNING DOWN	[M]	CP903	RJT003K010M1	10P CONNECTOR	[M]
D708	MTZJ15CTA	DIODE	[M]▲	S953	EVQ21405R	SW, TUNING UP	[M]	CP905	RJT003K010M1	10P CONNECTOR	[M]
D721	1N5402BM21	DIODE	[M]▲	S955	EVQ21405R	SW, MEMORY	[M]	CP1002	RJT100W07	7P CONNECTOR	[M]
D722	1N5402BM21	DIODE	[M]▲	S956	EVQ21405R	SW, CH PRESET DOWN	[M]				
D723	1N5402BM21	DIODE	[M]▲	S957	EVQ21405R	SW, CH PRESET UP	[M]			COILS & TRANSFORMERS	
D724	1N5402BM21	DIODE	[M]▲	S958	EVQ21405R	SW, HELP	[M]				
D725	1N5402BM21	DIODE	[M]▲	S960	EVQ21405R	SW, TUNER	[M]	L101	ELESN1R0MA	CHOKO COIL	[M]
D726	1N5402BM21	DIODE	[M]▲	S961	EVQ21405R	SW, CD	[M]	L103	ELEXTR47MA9	CHOKO COIL	[M]
D727	1N5402BM21	DIODE	[M]▲	S962	EVQ21405R	SW, TAPE	[M]	L105	RLQZB822KT-D	TAPING COIL	[M]
D728	1N5402BM21	DIODE	[M]▲	S963	EVQ21405R	SW, TV/DVD	[M]	L106	RLQZB822KT-D	TAPING COIL	[M]
D751	1SR35200TB	DIODE	[M]▲	S964	EVQ21405R	SW, VCR	[M]	L151	SLM1B10-1M	A.B. FILTER	[M]
D752	1SR35200TB	DIODE	[M]▲	S970	EVQ21405R	SW, SEARCH	[M]	L191	ELESNR56MA	CHOKO COIL	[M]
D753	1SR35200TB	DIODE	[M]▲	S971	EVQ21405R	SW, EON	[M]	L501	RLQZP1R0KT-Y	AXIAL COIL	[M]
D754	1SR35200TB	DIODE	[M]▲	S972	EVQ21405R	SW, PTY UP	[M]	L502	RLQZP1R0KT-Y	AXIAL COIL	[M]
D755	RVD1SS133TA	DIODE	[M]▲	S973	EVQ21405R	SW, PTY DOWN	[M]	L601	RLQYR73MW-E	CHOKO COIL	[M]
D756	MTZJ6R8BTA	DIODE	[M]▲	S974	EVQ21405R	SW, DISPLAY	[M]	L602	RLQYR73MW-E	CHOKO COIL	[M]
D771	RVD1SS133TA	DIODE	[M]	S980	EVQ21405R	SW, SPEAKER A	[M]	L651	RLQYR73MW-E	CHOKO COIL	[M]
D772	RVD1SS133TA	DIODE	[M]	S981	EVQ21405R	SW, SPEAKER B	[M]	L652	RLQYR73MW-E	CHOKO COIL	[M]
D773	MTZJ9R1CTA	DIODE	[M]	S983	EVQ21405R	SW, OFF/ON	[M]	L751	RLQB101KTA-Y	CHOKO COIL	[M]
D774	RVD1SS133TA	DIODE	[M]	S984	EVQ21405R	SW, PRO LOGIC	[M]	L791	SLQZ650MH49	AC LINE COIL	[M]▲
D781	RVD1SS133TA	DIODE	[M]	S985	EVQ21405R	SW, CENTER MODE	[M]	L901	RLQB101KTA-Y	CHOKO COIL	[M]
D782	RVD1SS133TA	DIODE	[M]					L902	RLQZP101KT-Y	AXIAL COIL	[M]
D901	1SS291TA	DIODE	[M]					L1051	RLQB101KTA-Y	CHOKO COIL	[M]
D903	MTZJ4R7BTA	DIODE	[M]					L701	RTP1P5B009-V	POWER TRANSFORMER	[M]▲

Ref No.	Part No.	Part Name & Description	Remarks	Ref No.	Part No.	Part Name & Description	Remarks	Ref No.	Part No.	Part Name & Description	Remarks
T751	RTP115E006	POWER TRANSFORMER	[M]△			FUSE CLIPS				EARTH TERMINALS	
		COMPONENT COMBINATION		FC701	EYF52BC	FUSE HOLDER	[M]	E401	SNE1004-2	EARTH TERMINAL	[M]
				FC702	EYF52BC	FUSE HOLDER	[M]	E691	SNE1004-2	EARTH TERMINAL	[M]
Z101	RLA2Z002M-T	AM ANT. COIL	[M]	FC705	EYF52BC	FUSE HOLDER	[M]			WIRES	
Z102	RLI2Z006M-T	AM IFT	[M]	FC706	EYF52BC	FUSE HOLDER	[M]				
Z120	ENV17290G1R	FM TUNER PACK	[M](EG)	FC707	EYF52BC	FUSE HOLDER	[M]				
Z120	ENV17290G1Y	FM TUNER PACK	[M](EB,E)	FC709	EYF52BC	FUSE HOLDER	[M]	W1	REE0814	WIRE	[M]
Z751	ERZV10V511CS	ZNR	[M]△			JACKS		W2	REE0818	WIRE	[M]
Z891	RCDSPS4242N	REMOTE SENSOR	[M]					W551	REZ0997	WIRE UNIT	[M]
		CERAMIC FILTERS		JK101	RJH4202	JK, ANT TERMINAL	[M]	W701	RWJ1812220KK	WIRE UNIT	[M]
				JK351	SJF3069-3N	JK, RCA PIN	[M]	W752	RWJ1803290CQ	WIRE	[M]
CF201	RLFFETM9D01L	CERAMIC CAPACITOR	[M]	JK401	SJF3069-7N	JK, RCA TERMINAL	[M]			PACKING MATERIALS	
CF202	RLFFETM9D01L	CERAMIC FILTER	[M]	JK402	SJF3069N	JK, LINE IN	[M]				
CF901	RVBCST4R00MT	CERAMIC OSCILLATOR	[M]	JK403	SJF3069-7N	JK, RCA TERMINAL	[M]	P1	SPSD152	ACCESSORY BOX	[M]
CF902	RSXZ456KM07M	CERAMIC OSCILLATOR	[M]	JK404	SJF3069N	JK, LINE IN	[M]	P2	RPFX00065	MIRAMAT BAG	[M]
CF1051	EF0EC9004T4	CERAMIC OSCILLATOR	[M]	JK405	SJFD7	JK, FM MULTI OUT	[M]	P3	RPG3464	PACKING CASE	[M](E)
		OSCILLATORS		JK406	SJF3069-7N	JK, RCA TERMINAL	[M]	P3	RPG3536	PACKING CASE	[M](EB,EG)
				JK601	RJR0054	JK, SP TERMINAL	[M]	P4	RPNC966	POLYFOAM	[M]
				JK602	RJH5601	JK, SP TERMINAL	[M]			ACCESSORIES	
X101	RSXZ456KM07M	CERAMIC OSCILLATOR	[M]	JK603	RJR0054	JK, SP TERMINAL	[M]				
X102	RLFDGTD01I	FM REZONATOR	[M]	JK794	SJS9231-1B	JK, AC INLET	[M]△	A1	EUR644377	REMOTE CONTROL	[M]
X103	SVQ49U722T-S	CRYSTAL 7.2MHZ	[M]			RELAYS		A1-1	UR64EC1822	BATTERY COVER	[M]
		DISPLAY TUBE						A2	RSA0010	LOOP ANT UNIT	[M]
				RL601	RSY0013M-0	RELAY	[M]	A3	RJA0019-2K	AC CORD (SF)△	[M](EG,E)
FL901	RSL0233-F	FL	[M]	RL602	RSY0013M-0	RELAY	[M]	A3	VJA0733	AC CORD (SF)△	[M](EB)
		FUSES		RL603	RSY0013M-0	RELAY	[M]	A4	RSA0007	FM ANTENA	[M]
				RL751	RSY0019M-0	12V TV-5 RELAY	[M]△	A5	RFKSEX510EBK	INSTR. MANUAL ASS'Y	[M](EB)
F1	XBA2C25TB0	FUSE	[M]△			HEADPHONE		A5	RFKSEX510EGK	INSTR. MANUAL ASS'Y	[M](EG)
F3	XBA2C63TB0	FUSE	[M]△					A5	RFKSEX510E-K	INSTR. MANUAL ASS'Y	[M](E)
F4	XBA2C63TB0	FUSE	[M]△	HP601	RJJ63TS01	HEADPHONES JACK	[M]	A6	SJP9009	ANT ADAPTER	[M](EB)

## Resistors & Capacitors

Notes : \* Important safety notice:

Components identified by △ mark have special characteristics important for safety.

Furthermore, special parts which have purposes of fire-retardant (resistors), high-quality sound (capacitors), low-noise (resistors), etc. are used. When replacing any of components, be sure to use only manufacturer's specified parts shown in the parts list.

\* Capacitor values are in microfarad (μF) unless specified otherwise, P=Pico-farads (pF) F=Farads (F)

\* Resistors values are in ohms, unless specified otherwise, 1k=1,000(OHM), 1M=1,000k(OHM)

Ref No.	Part No.	Values & Remarks	Ref No.	Part No.	Values & Remarks	Ref No.	Part No.	Values & Remarks	Ref No.	Part No.	Values & Remarks
		RESISTORS									
			R107	ERDS2TJ471T	470 1/4W [M]	R116	ERDS2TJ102T	1K 1/4W [M]	R122	ERDS2TJ272T	2.7K 1/4W [M]
			R110	ERDS2TJ102T	1K 1/4W [M]	R117	ERDS2TJ473T	47K 1/4W [M]	R124	ERDS2TJ271T	270 1/4W [M]
R103	ERDS2TJ101T	100 1/4W [M]	R112	ERDS2TJ104T	100K 1/4W [M]	R118	ERDS2TJ562T	5.6K 1/4W [M]	R125	ERDS2TJ472T	4.7K 1/4W [M]
R104	ERDS2TJ102T	1K 1/4W [M]	R113	ERDS2TJ103T	10K 1/4W [M]	R119	ERDS2TJ183T	18K 1/4W [M]	R126	ERDS2TJ472T	4.7K 1/4W [M]
R105	ERDS2TJ471T	470 1/4W [M]	R114	ERDS2TJ562T	5.6K 1/4W [M]	R120	ERDS2TJ473T	47K 1/4W [M]	R127	ERDS2TJ103T	10K 1/4W [M]
R106	ERDS2TJ224T	220K 1/4W [M]	R115	ERDS2TJ561T	560 1/4W [M]	R121	ERDS2TJ332T	3.3K 1/4W [M]	R128	ERDS2TJ820T	82 1/4W [M]

Ref No.	Part No.	Values & Remarks	Ref No.	Part No.	Values & Remarks	Ref No.	Part No.	Values & Remarks	Ref No.	Part No.	Values & Remarks
R129	ERDS2TJ473T	47K 1/4W [M]	R413	ERDS2TJ102T	1K 1/4W [M]	R503	ERDS2TJ103T	10K 1/4W [M]	R583	ERDS2TJ102T	1K 1/4W [M]
R130	ERDS2TJ102T	1K 1/4W [M]	R414	ERDS2TJ102T	1K 1/4W [M]	R504	ERDS2TJ103T	10K 1/4W [M]	R584	ERDS2TJ102T	1K 1/4W [M]
R131	ERDS2TJ102T	1K 1/4W [M]	R415	ERDS2TJ102T	1K 1/4W [M]	R505	ERDS2TJ103T	10K 1/4W [M]	R585	ERDS2TJ102T	1K 1/4W [M]
R132	ERDS2TJ103T	10K 1/4W [M]	R416	ERDS2TJ102T	1K 1/4W [M]	R506	ERDS2TJ103T	10K 1/4W [M]	R586	ERDS2TJ102T	1K 1/4W [M]
R133	ERDS2TJ102T	1K 1/4W [M]	R417	ERDS2TJ473T	47K 1/4W [M]	R508	ERDS1FVJ2F2T	2.2 1/2W[M]△	R587	ERDS2TJ102T	1K 1/4W [M]
R134	ERDS2TJ102T	1K 1/4W [M]	R418	ERDS2TJ473T	47K 1/4W [M]	R511	ERDS2TJ471T	470 1/4W [M]	R588	ERDS2TJ102T	1K 1/4W [M]
R135	ERDS2TJ102T	1K 1/4W [M]	R419	ERDS2TJ104T	100K 1/4W [M]	R512	ERDS2TJ471T	470 1/4W [M]	R589	ERDS2TJ272T	2.7K 1/4W [M]
R136	ERDS2TJ102T	1K 1/4W [M]	R420	ERDS2TJ104T	100K 1/4W [M]	R513	ERDS2TJ474T	470K 1/4W [M]	R590	ERDS2TJ473T	47K 1/4W [M]
R137	ERDS2TJ102T	1K 1/4W [M]	R421	ERDS2TJ104T	100K 1/4W [M]	R514	ERDS2TJ474T	470K 1/4W [M]	R591	ERDS2TJ222T	2.2K 1/4W [M]
R139	ERDS2TJ272T	2.7K 1/4W [M]	R422	ERDS2TJ104T	100K 1/4W [M]	R515	ERDS2TJ474T	470K 1/4W [M]	R592	ERDS2TJ222T	2.2K 1/4W [M]
R140	ERDS2TJ272T	2.7K 1/4W [M]	R423	ERDS2TJ102T	1K 1/4W [M]	R516	ERDS2TJ474T	470K 1/4W [M]	R596	ERDS2TJ102T	1K 1/4W [M]
R141	ERDS2TJ102T	1K 1/4W [M]	R424	ERDS2TJ102T	1K 1/4W [M]	R517	ERDS2TJ332T	3.3K 1/4W [M]	R597	ERDS2TJ272T	2.7K 1/4W [M]
R142	ERDS2TJ102T	1K 1/4W [M]	R425	ERDS2TJ103T	10K 1/4W [M]	R518	ERDS2TJ332T	3.3K 1/4W [M]	R598	ERDS2TJ272T	2.7K 1/4W [M]
R143	ERDS2TJ222T	2.2K 1/4W [M]	R426	ERDS2TJ103T	10K 1/4W [M]	R519	ERDS2TJ182T	1.8K 1/4W [M]	R599	ERDS2TJ102T	1K 1/4W [M]
R144	ERDS2TJ222T	2.2K 1/4W [M]	R427	ERDS2TJ103T	10K 1/4W [M]	R520	ERDS2TJ182T	1.8K 1/4W [M]	R601	ERDS2TJ102T	1K 1/4W [M]
R145	ERDS2TJ102T	1K 1/4W[M](EB,E	R433	ERDS2TJ102T	1K 1/4W [M]	R521	ERDS2TJ223T	22K 1/4W [M]	R602	ERDS2TJ102T	1K 1/4W [M]
R145	ERDS2TJ561T	560 1/4W[M](EG)	R434	ERDS2TJ102T	1K 1/4W [M]	R522	ERDS2TJ223T	22K 1/4W [M]	R603	ERDS2TJ563T	56K 1/4W [M]
R146	ERDS2TJ102T	1K 1/4W[M](EB,E	R440	ERDS1FVJ560T	56 1/2W[M]△	R523	ERDS2TJ392T	3.9K 1/4W [M]	R604	ERDS2TJ563T	56K 1/4W [M]
R146	ERDS2TJ561T	560 1/4W[M](EG)	R441	ERDS2TJ473T	47K 1/4W [M]	R524	ERDS2TJ392T	3.9K 1/4W [M]	R605	ERDS2TJ182T	1.8K 1/4W [M]
R147	ERDS2TJ474T	470K 1/4W [M]	R442	ERDS2TJ473T	47K 1/4W [M]	R525	ERDS2TJ222T	2.2K 1/4W [M]	R606	ERDS2TJ182T	1.8K 1/4W [M]
R148	ERDS2TJ474T	470K 1/4W [M]	R443	ERDS1FVJ560T	56 1/2W[M]△	R526	ERDS2TJ222T	2.2K 1/4W [M]	R607	ERDS2TJ563T	56K 1/4W [M]
R149	ERDS2TJ680T	68 1/4W [M]	R451	ERDS2TJ224T	220K 1/4W [M]	R527	ERDS2TJ122T	1.2K 1/4W [M]	R608	ERDS2TJ563T	56K 1/4W [M]
R171	ERDS2TJ102T	1K 1/4W [M]	R452	ERDS2TJ224T	220K 1/4W [M]	R528	ERDS2TJ122T	1.2K 1/4W [M]	R609	ERDS2TJ470T	47 1/4W [M]
R172	ERDS2TJ102T	1K 1/4W [M]	R453	ERDS2TJ391T	390 1/4W [M]	R529	ERDS2TJ273T	27K 1/4W [M]	R610	ERDS2TJ470T	47 1/4W [M]
R173	ERDS2TJ471T	470 1/4W [M]	R454	ERDS2TJ391T	390 1/4W [M]	R530	ERDS2TJ273T	27K 1/4W [M]	R611	ERDS1FVJ100T	10 1/2W [M]
R175	ERDS2TJ102T	1K 1/4W [M]	R455	ERDS2TJ563T	56K 1/4W [M]	R531	ERDS2TJ332T	3.3K 1/4W [M]	R612	ERDS1FVJ100T	10 1/2W [M]
R176	ERDS2TJ391T	390 1/4W [M]	R456	ERDS2TJ563T	56K 1/4W [M]	R532	ERDS2TJ332T	3.3K 1/4W [M]	R613	ERDS2TJ102T	1K 1/4W [M]
R181	ERDS2TJ332T	3.3K 1/4W [M]	R457	ERDS2TJ271T	270 1/4W [M]	R533	ERDS2TJ224T	220K 1/4W [M]	R614	ERDS2TJ102T	1K 1/4W [M]
R351	ERDS2TJ750T	75 1/4W [M]	R458	ERDS2TJ271T	270 1/4W [M]	R534	ERDS2TJ224T	220K 1/4W [M]	R615	ERDS2TJ184T	180K 1/4W [M]
R352	ERDS2TJ750T	75 1/4W [M]	R459	ERDS2TJ680T	68 1/4W [M]	R537	ERDS2TJ103T	10K 1/4W [M]	R616	ERDS2TJ154T	150K 1/4W [M]
R353	ERDS2TJ103T	10K 1/4W [M]	R460	ERDS2TJ680T	68 1/4W [M]	R538	ERDS2TJ103T	10K 1/4W [M]	R617	ERDS2TJ473T	47K 1/4W [M]
R354	ERDS2TJ103T	10K 1/4W [M]	R461	ERDS2TJ184T	180K 1/4W [M]	R539	ERDS2TJ332T	3.3K 1/4W [M]	R618	ERDS2TJ473T	47K 1/4W [M]
R355	ERDS2TJ750T	75 1/4W [M]	R462	ERDS2TJ184T	180K 1/4W [M]	R540	ERDS2TJ332T	3.3K 1/4W [M]	R619	ERDS2TJ223T	22K 1/4W [M]
R356	ERDS2TJ750T	75 1/4W [M]	R463	ERDS2TJ123T	12K 1/4W [M]	R541	ERDS2TJ182T	1.8K 1/4W [M]	R620	ERD25FVJ220T	22 1/4W [M]
R357	ERDS2TJ102T	1K 1/4W [M]	R464	ERDS2TJ123T	12K 1/4W [M]	R542	ERDS2TJ182T	1.8K 1/4W [M]	R621	ERDS2TJ332T	3.3K 1/4W [M]
R358	ERDS2TJ102T	1K 1/4W [M]	R465	ERDS2TJ563T	56K 1/4W [M]	R543	ERDS2TJ102T	1K 1/4W [M]	R622	ERDS2TJ334T	330K 1/4W [M]
R359	ERDS2TJ182T	1.8K 1/4W [M]	R466	ERDS2TJ563T	56K 1/4W [M]	R544	ERDS2TJ102T	1K 1/4W [M]	R623	ERDS2TJ684T	680K 1/4W [M]
R360	ERDS2TJ182T	1.8K 1/4W [M]	R469	ERDS2TJ102T	1K 1/4W [M]	R545	ERDS2TJ684T	680K 1/4W [M]	R624	ERDS2TJ154T	150K 1/4W [M]
R361	ERD2FCVG220T	22 1/4W [M]	R470	ERDS2TJ102T	1K 1/4W [M]	R546	ERDS2TJ103T	10K 1/4W [M]	R625	ERDS2TJ154T	150K 1/4W [M]
R362	ERD2FCVG220T	22 1/4W [M]	R481	ERDS2TJ333T	33K 1/4W [M]	R550	ERDS2TJ332T	3.3K 1/4W [M]	R626	ERD25FVJ330T	33 1/4W[M]△
R401	ERDS2TJ102T	1K 1/4W [M]	R482	ERDS2TJ333T	33K 1/4W [M]	R551	ERDS2TJ102T	1K 1/4W [M]	R627	ERDS2TJ101T	100 1/4W [M]
R402	ERDS2TJ102T	1K 1/4W [M]	R483	ERDS2TJ183T	18K 1/4W [M]	R552	ERDS2TJ102T	1K 1/4W [M]	R628	ERD25FVJ330T	33 1/4W[M]△
R405	ERDS2TJ102T	1K 1/4W [M]	R484	ERDS2TJ681T	680 1/4W [M]	R553	ERDS2TJ104T	100K 1/4W [M]	R629	ERD25FVJ390T	39 1/4W[M]△
R406	ERDS2TJ102T	1K 1/4W [M]	R485	ERDS2TJ224T	220K 1/4W [M]	R554	ERDS2TJ104T	100K 1/4W [M]	R630	ERD25FVJ390T	39 1/4W[M]△
R407	ERDS2TJ102T	1K 1/4W [M]	R486	ERDS2TJ102T	1K 1/4W [M]	R555	ERDS2TJ223T	22K 1/4W [M]	R631	ERDS2TJ274T	270K 1/4W [M]
R408	ERDS2TJ102T	1K 1/4W [M]	R487	ERDS2TJ472T	4.7K 1/4W [M]	R556	ERDS2TJ223T	22K 1/4W [M]	R632	ERDS2TJ223T	22K 1/4W [M]
R411	ERDS2TJ102T	1K 1/4W [M]	R501	ERDS2TJ222T	2.2K 1/4W [M]	R557	ERDS2TJ681T	680 1/4W [M]	R637	ERG1SJ101E	100 1W[M]△
R412	ERDS2TJ102T	1K 1/4W [M]	R502	ERDS2TJ222T	2.2K 1/4W [M]	R558	ERDS2TJ681T	680 1/4W [M]	R638	ERG1SJ101E	100 1W[M]△

Ref No.	Part No.	Values & Remarks	Ref No.	Part No.	Values & Remarks	Ref No.	Part No.	Values & Remarks	Ref No.	Part No.	Values & Remarks
R639	ERG1S101E	100 1W[M]▲	R690	ERDS2TJ270T	27 1/4W [M]	R793	ERDS2TJ223T	22K 1/4W [M]	R971	ERDS2TJ122T	1.2K 1/4W [M]
R640	ERG1S101E	100 1W[M]▲	R691	ERDS2TJ270T	27 1/4W [M]	R794	ERDS2TJ223T	22K 1/4W [M]	R972	ERDS2TJ152T	1.5K 1/4W [M]
R642	ERDS2TJ104T	100K 1/4W [M]	R692	ERDS2TJ270T	27 1/4W [M]	R795	ERDS2TJ223T	22K 1/4W [M]	R973	ERDS2TJ182T	1.8K 1/4W [M]
R643	ERDS2TJ683T	68K 1/4W [M]	R693	ERDS2TJ270T	27 1/4W [M]	R796	ERDS2TJ223T	22K 1/4W [M]	R974	ERDS2TJ222T	2.2K 1/4W [M]
R644	ERDS2TJ682T	6.8K 1/4W [M]	R694	ERDS2TJ270T	27 1/4W [M]	R797	ERDS2TJ682T	6.8K 1/4W [M]	R975	ERDS2TJ332T	3.3K 1/4W [M]
R645	ERDS2TJ682T	6.8K 1/4W [M]	R695	ERDS2TJ102T	1K 1/4W [M]	R799	ERDS2TJ682T	6.8K 1/4W [M]	R980	ERDS2TJ102T	1K 1/4W [M]
R646	ERDS2TJ682T	6.8K 1/4W [M]	R696	ERDS2TJ102T	1K 1/4W [M]	R901	ERDS2TJ102T	1K 1/4W [M]	R981	ERDS2TJ122T	1.2K 1/4W [M]
R647	ERDS2TJ221T	220 1/4W [M]	R697	ERDS2TJ221T	220 1/4W [M]	R906	ERDS2TJ104T	100K 1/4W [M]	R982	ERDS2TJ152T	1.5K 1/4W [M]
R648	ERDS2TJ221T	220 1/4W [M]	R698	ERDS2TJ221T	220 1/4W [M]	R907	ERDS2TJ104T	100K 1/4W [M]	R983	ERDS2TJ182T	1.8K 1/4W [M]
R651	ERDS2TJ102T	1K 1/4W [M]	R699	ERDS2TJ332T	3.3K 1/4W [M]	R908	ERDS2TJ104T	100K 1/4W [M]	R984	ERDS2TJ222T	2.2K 1/4W [M]
R652	ERDS2TJ102T	1K 1/4W [M]	R703	ERDS1FVJ3R9T	3.9 1/2W[M]▲	R909	ERDS2TJ104T	100K 1/4W [M]	R1001	ERDS2TJ102T	1K 1/4W [M]
R653	ERDS2TJ563T	56K 1/4W [M]	R704	ERDS1FVJ3R9T	3.9 1/2W[M]▲	R910	ERDS2TJ102T	1K 1/4W [M]	R1002	ERDS2TJ102T	1K 1/4W [M]
R654	ERDS2TJ563T	56K 1/4W [M]	R705	ERDS2TJ472T	4.7K 1/4W [M]	R911	ERDS2TJ104T	100K 1/4W [M]	R1003	ERDS2TJ102T	1K 1/4W [M]
R655	ERDS2TJ182T	1.8K 1/4W [M]	R706	ERDS2TJ102T	1K 1/4W [M]	R913	ERDS2TJ104T	100K 1/4W [M]	R1004	ERDS2TJ102T	1K 1/4W [M]
R656	ERDS2TJ182T	1.8K 1/4W [M]	R707	ERD25FVJ221T	220 1/4W[M]▲	R917	ERDS2TJ103T	10K 1/4W [M]	R1005	ERDS2TJ203T	20K 1/4W [M]
R657	ERDS2TJ563T	56K 1/4W [M]	R708	ERDS2TJ152T	1.5K 1/4W [M]	R920	ERDS2TJ271T	270 1/4W [M]	R1007	ERDS2TJ473T	47K 1/4W [M]
R658	ERDS2TJ563T	56K 1/4W [M]	R709	ERDS2TJ1R5T	1.5 1/4W [M]	R921	ERDS2TJ121T	120 1/4W [M]	R1008	ERDS2TJ473T	47K 1/4W [M]
R659	ERDS2TJ470T	47 1/4W [M]	R710	ERDS2TJ1R5T	1.5 1/4W [M]	R922	ERDS2TJ472T	4.7K 1/4W [M]	R1009	ERDS2TJ332T	3.3K 1/4W [M]
R660	ERDS2TJ470T	47 1/4W [M]	R711	ERDS2TJ752T	7.5K 1/4W [M]	R924	ERDS2TJ333T	33K 1/4W [M]	R1010	ERDS2TJ332T	3.3K 1/4W [M]
R661	ERDS1FVJ100T	10 1/2W [M]	R712	ERDS2TJ682T	6.8K 1/4W [M]	R927	ERDS2TJ181T	180 1/4W [M]	R1011	ERDS2TJ332T	3.3K 1/4W [M]
R662	ERDS1FVJ100T	10 1/2W [M]	R713	ERDS2TJ390T	39 1/4W [M]	R928	ERDS2TJ121T	120 1/4W [M]	R1012	ERDS2TJ102T	1K 1/4W [M]
R663	ERDS2TJ102T	1K 1/4W [M]	R714	ERDS2TJ390T	39 1/4W [M]	R929	ERDS2TJ101T	100 1/4W [M]	R1013	ERDS2TJ103T	10K 1/4W [M]
R664	ERDS2TJ102T	1K 1/4W [M]	R721	ERD2FCVG331T	330 1/4W[M]▲	R930	ERDS2TJ101T	100 1/4W [M]	R1014	ERDS2TJ104T	100K 1/4W [M]
R665	ERDS2TJ154T	150K 1/4W [M]	R722	ERDS2TJ123T	12K 1/4W [M]	R936	ERDS2TJ104T	100K 1/4W [M]	R1051	ERDS2TJ393T	39K 1/4W [M]
R666	ERDS2TJ184T	180K 1/4W [M]	R723	ERDS1FVJ3R9T	3.9 1/2W[M]▲	R937	ERDS2TJ104T	100K 1/4W [M]	R1052	ERDS2TJ105T	1M 1/4W [M]
R667	ERDS2TJ473T	47K 1/4W [M]	R724	ERDS1FVJ3R9T	3.9 1/2W[M]▲	R941	ERDS2TJ472T	4.7K 1/4W [M]	R1053	ERDS2TJ102T	1K 1/4W [M]
R668	ERDS2TJ473T	47K 1/4W [M]	R725	ERDS2TJ821T	820 1/4W [M]	R943	ERDS2TJ102T	1K 1/4W [M]	R1055	ERDS2TJ224T	220K 1/4W [M]
R669	ERDS2TJ223T	22K 1/4W [M]	R726	ERD25FVJ101T	100 1/4W[M]▲	R944	ERDS2TJ104T	100K 1/4W [M]	R1056	ERDS2TJ153T	15K 1/4W [M]
R670	ERD25FVJ220T	22 1/4W [M]	R727	ERD25FVJ101T	100 1/4W[M]▲	R945	ERDS2TJ104T	100K 1/4W [M]	R1061	ERDS2TJ222T	2.2K 1/4W [M]
R671	ERDS2TJ332T	3.3K 1/4W [M]	R729	ERDS2TJ684T	680K 1/4W [M]	R946	ERDS2TJ103T	10K 1/4W [M]	R1062	ERDS2TJ273T	27K 1/4W [M]
R672	ERDS2TJ334T	330K 1/4W [M]	R730	ERDS1FVJ5R6T	5.6 1/2W[M]▲	R947	ERDS2TJ103T	10K 1/4W [M]	R1063	ERDS2TJ332T	3.3K 1/4W [M]
R673	ERDS2TJ684T	680K 1/4W [M]	R754	ERDS2TJ102T	1K 1/4W [M]	R948	ERDS2TJ103T	10K 1/4W [M]			
R674	ERDS2TJ154T	150K 1/4W [M]	R771	ERDS2TJ473T	47K 1/4W [M]	R949	ERDS2TJ103T	10K 1/4W [M]			CAPACITORS
R675	ERDS2TJ154T	150K 1/4W [M]	R772	ERDS2TJ473T	47K 1/4W [M]	R950	ERDS2TJ102T	1K 1/4W [M]			
R676	ERDS2TJ274T	270K 1/4W [M]	R773	ERDS2TJ103T	10K 1/4W [M]	R951	ERDS2TJ122T	1.2K 1/4W [M]	C101	ECBT1C103NS5	0.01 16V [M]
R677	ERDS2TJ101T	100 1/4W [M]	R774	ERDS2TJ335T	3.3M 1/4W [M]	R952	ERDS2TJ152T	1.5K 1/4W [M]	C103	ECBT1C103NS5	0.01 16V [M]
R678	ERD25FVJ330T	33 1/4W[M]▲	R775	ERDS2TJ331T	330 1/4W [M]	R953	ERDS2TJ182T	1.8K 1/4W [M]	C104	ECBT1H102KB5	1000P 50V [M]
R679	ERD25FVJ390T	39 1/4W[M]▲	R776	ERDS1FVJ4R7T	4.7 1/2W[M]▲	R954	ERDS2TJ222T	2.2K 1/4W [M]	C105	ECBT1H470J5	47P 50V [M]
R680	ERD25FVJ390T	39 1/4W[M]▲	R777	ERDS2TJ224T	220K 1/4W [M]	R955	ERDS2TJ332T	3.3K 1/4W [M]	C106	ECBT1C103NS5	0.01 16V [M]
R681	ERDS2TJ270T	27 1/4W [M]	R778	ERDS2TJ472T	4.7K 1/4W [M]	R956	ERDS2TJ472T	4.7K 1/4W [M]	C107	ECBT1H473ZF5	0.047 50V [M]
R682	ERDS2TJ270T	27 1/4W [M]	R779	ERDS2TJ103T	10K 1/4W [M]	R957	ERDS2TJ682T	6.8K 1/4W [M]	C108	ECBT1H3R2KC5	8.2P 50V [M]
R683	ERDS2TJ270T	27 1/4W [M]	R782	ERDS2TJ470T	47 1/4W [M]	R958	ERDS2TJ123T	12K 1/4W [M]	C109	ECBT1C103NS5	0.01 16V [M]
R684	ERDS2TJ270T	27 1/4W [M]	R783	ERDS2TJ103T	10K 1/4W [M]	R960	ERDS2TJ102T	1K 1/4W [M]	C110	ECBT1C103NS5	0.01 16V [M]
R685	ERDS2TJ270T	27 1/4W [M]	R784	ERDS2TJ154T	150K 1/4W [M]	R961	ERDS2TJ122T	1.2K 1/4W [M]	C111	ECEA1EKA4R7B	4.7 25V [M]
R686	ERDS2TJ270T	27 1/4W [M]	R785	ERDS2TJ103T	10K 1/4W [M]	R962	ERDS2TJ152T	1.5K 1/4W [M]	C112	ECBT1C103NS5	0.01 16V [M]
R687	ERDS2TJ270T	27 1/4W [M]	R786	ERDS2TJ154T	150K 1/4W [M]	R963	ERDS2TJ182T	1.8K 1/4W [M]	C113	ECBT1H102KB5	1000P 50V [M]
R688	ERDS2TJ270T	27 1/4W [M]	R791	ERDS2TJ223T	22K 1/4W [M]	R964	ERDS2TJ222T	2.2K 1/4W [M]	C114	ECEA1HKA3R9B	3.3 50V [M]
R689	ERDS2TJ270T	27 1/4W [M]	R792	ERDS2TJ223T	22K 1/4W [M]	R970	ERDS2TJ102T	1K 1/4W [M]	C115	ECEA1EKA4R7B	4.7 25V [M]

Ref No.	Part No.	Values & Remarks	Ref No.	Part No.	Values & Remarks	Ref No.	Part No.	Values & Remarks	Ref No.	Part No.	Values & Remarks
C116	ECBT1C822MS5	8200P 16V [M]	C357	ECA1AM470B	47 10V [M]	C466	ECBT1E103ZF5	0.01 25V [M]	C560	ECEA1CKA100B	10 16V [M]
C117	ECQB1H471JM3	470P 50V [M]	C358	ECA1AM470B	47 10V [M]	C469	ECBT1H181KB5	180P 50V [M]	C583	ECA1AM470B	47 10V [M]
C118	ECQB1H103JM3	0.01 50V [M]	C359	ECBT1E103ZF5	0.01 25V [M]	C470	ECBT1H181KB5	180P 50V [M]	C584	ECA1AM470B	47 10V [M]
C119	ECQB1H103JM3	0.01 50V [M]	C360	ECBT1E103ZF5	0.01 25V [M]	C480	ECBT1E103ZF5	0.01 25V [M]	C601	ECEA1HN3R3SB	3.3 50V [M]
C120	ECEA1HKA010B	1 50V [M]	C401	ECEA1VKA4R7B	4.7 35V[M]△	C481	ECEA1HN010SB	1 50V [M]	C602	ECEA1HN3R3SB	3.3 50V [M]
C121	ECEA1HKA010B	1 50V [M]	C402	ECEA1VKA4R7B	4.7 35V[M]△	C482	ECEA1VU4R7B	4.7 35V [M]	C603	ECBT1H681KB5	680P 50V [M]
C122	ECEA1HKA2R2B	2.2 50V [M]	C403	ECBT1E103ZF5	0.01 25V [M]	C483	ECBT1H101KB5	100P 50V [M]	C604	ECBT1H681KB5	680P 50V [M]
C123	ECEA1HKA010B	1 50V [M]	C404	ECBT1E103ZF5	0.01 25V [M]	C503	ECEA0JKA101B	100 6.3V [M]	C605	ECEA1JU220B	22 63V [M]
C124	ECBT1H102KB5	1000P 50V [M]	C405	ECBT1H101KB5	100P 50V [M]	C504	ECEA0JKA101B	100 6.3V [M]	C606	ECEA1JU220B	22 63V [M]
C125	ECBT1H150JC5	15P 50V [M]	C406	ECBT1H101KB5	100P 50V [M]	C505	ECFR1C104MR	0.1 16V [M]	C607	ECCR1H100K5	10P 50V [M]
C126	ECBT1H104ZF5	0.1 50V [M]	C409	ECA1EM220B	22 25V[M]△	C506	ECFR1C104MR	0.1 16V [M]	C608	ECCR1H100K5	10P 50V [M]
C127	ECEA1CKA220B	22 16V [M]	C410	ECA1EM220B	22 25V[M]△	C511	ECEA1HKA3R3B	3.3 50V [M]	C609	ECBT1H221KB5	220P 50V [M]
C128	ECBT1C103NS5	0.01 16V [M]	C411	ECBT1H101KB5	100P 50V [M]	C512	ECEA1HKA3R3B	3.3 50V [M]	C610	ECBT1H221KB5	220P 50V [M]
C129	ECEA0JKA101B	100 6.3V [M]	C412	ECBT1H101KB5	100P 50V [M]	C513	ECBT1H150J5	15P 50V [M]	C611	ECQV1H104JM3	0.1 50V [M]
C130	ECEA0JKA101B	100 6.3V [M]	C413	ECA1CM100B	10 16V [M]	C514	ECBT1H150J5	15P 50V [M]	C612	ECQV1H104JM3	0.1 50V [M]
C131	ECBT1C103NS5	0.01 16V [M]	C414	ECA1CM100B	10 16V [M]	C515	ECBT1H221KB5	220P 50V [M]	C613	ECBT1H681KB5	680P 50V [M]
C132	ECBT1H102KB5	1000P 50V [M]	C415	ECBT1E103ZF5	0.01 25V [M]	C516	ECBT1H221KB5	220P 50V [M]	C614	ECBT1H681KB5	680P 50V [M]
C133	ECBT1H150JC5	15P 50V [M]	C416	ECBT1E103ZF5	0.01 25V [M]	C517	ECBT1H330J5	33P 50V [M]	C615	ECA1JM330B	33 6.3V [M]
C134	ECBT1H180JC5	18P 50V [M]	C417	ECBT1H101KB5	100P 50V [M]	C518	ECBT1H330J5	33P 50V [M]	C616	ECEA2AU100B	10 100V [M]
C135	ECBT1C103MS5	0.01 16V [M]	C418	ECBT1H101KB5	100P 50V [M]	C519	ECEA1VKA4R7B	4.7 35V [M]	C617	ECEA1JU220B	22 63V [M]
C136	ECBT1C103MS5	0.01 16V [M]	C419	ECBT1H331KB5	330P 50V [M]	C520	ECEA1VKA4R7B	4.7 35V [M]	C618	ECEA2AN2R2SB	2.2 100V [M]
C137	ECBT1H561KB5	560P 50V [M]	C420	ECBT1H331KB5	330P 50V [M]	C521	ECEA1VKA4R7B	4.7 35V [M]	C619	ECBT1H102KB5	1000P 50V [M]
C138	ECBT1H561KB5	560P 50V [M]	C421	ECBT1H331KB5	330P 50V [M]	C522	ECEA1VKA4R7B	4.7 35V [M]	C621	ECEA2AU100B	10 100V [M]
C139	ECQB1H682JM3	6800P 50V [M]	C422	ECBT1H331KB5	330P 50V [M]	C523	ECFR1E123KR	0.012 25V [M]	C622	ECEA2AU100B	10 100V [M]
C140	ECQB1H682JM3	6800P 50V [M]	C423	ECBT1H101KB5	100P 50V [M]	C524	ECFR1E123KR	0.012 25V [M]	C631	ECKR1H223ZF5	0.022 50V [M]
C141	ECEA1HKA010B	1 50V [M]	C424	ECBT1H101KB5	100P 50V [M]	C525	ECQV1H683JM3	0.068 50V [M]	C632	ECKR1H223ZF5	0.022 50V [M]
C142	ECEA1HKA010B	1 50V [M]	C425	ECBT1H101KB5	100P 50V [M]	C526	ECQV1H683JM3	0.068 50V [M]	C633	ECKR1H223ZF5	0.022 50V [M]
C143	ECEA1HKA010B	1 50V [M]	C426	ECBT1H101KB5	100P 50V [M]	C527	ECBT1C562KR5	5600P 16V [M]	C634	ECKR1H223ZF5	0.022 50V [M]
C144	ECEA1HKA010B	1 50V [M]	C427	ECBT1H221KB5	220P 50V [M]	C528	ECBT1C562KR5	5600P 16V [M]	C635	ECKR1H223ZF5	0.022 50V [M]
C145	ECBT1H220JC5	22P 50V [M]	C428	ECBT1H221KB5	220P 50V [M]	C529	ECQB1H273JM3	0.027 50V [M]	C636	ECKR1H223ZF5	0.022 50V [M]
C146	ECBT1H331KB5	330P 50V [M]	C431	ECA1CM100B	10 16V [M]	C530	ECQB1H273JM3	0.027 50V [M]	C637	ECKR1H223ZF5	0.022 50V [M]
C147	ECBT1H102KB5	1000P 50V [M]	C432	ECA1CM100B	10 16V [M]	C531	ECBT1E103ZF5	0.01 25V [M]	C638	ECKR1H223ZF5	0.022 50V [M]
C148	ECBT1C103NS5	0.01 16V [M]	C440	ECBT1E103ZF5	0.01 25V [M]	C532	ECBT1E103ZF5	0.01 25V [M]	C641	ECKR1H102ZF5	1000P 50V [M]
C149	ECBT1C103NS5	0.01 16V [M]	C451	ECEA1VU4R7B	4.7 35V [M]	C533	ECEA1CKA100B	10 16V [M]	C642	ECKR1H102ZF5	1000P 50V [M]
C150	ECBT1H104ZF5	0.1 50V [M]	C452	ECEA1VU4R7B	4.7 35V [M]	C534	ECEA1CKA100B	10 16V [M]	C643	ECBT1H470J5	47P 50V [M]
C172	ECBT1H331KB5	330P 50V [M]	C453	ECBT1H100JC5	10P 50V [M]	C535	ECBT1H104ZF5	0.1 50V [M]	C651	ECEA1HN3R3SB	3.3 50V [M]
C173	ECEA1CKA220B	22 16V [M]	C454	ECBT1H100JC5	10P 50V [M]	C536	ECBT1E103ZF5	0.01 25V [M]	C652	ECEA1HN3R3SB	3.3 50V [M]
C174	ECEA1CKA101B	100 16V [M]	C455	ECBT1H102KB5	1000P 50V [M]	C537	ECA1CM100B	10 16V [M]	C653	ECBT1H681KB5	680P 50V [M]
C175	ECBT1C103NS5	0.01 16V [M]	C456	ECBT1H102KB5	1000P 50V [M]	C538	ECA1CM100B	10 16V [M]	C654	ECBT1H681KB5	680P 50V [M]
C176	ECBT1C103NS5	0.01 16V [M]	C457	ECEA1AU330B	33 10V [M]	C551	ECEA1HKA3R3B	3.3 50V [M]	C655	ECEA1JU220B	22 63V [M]
C181	ECBT1H471KB5	470P 50V [M]	C458	ECEA1AU330B	33 10V [M]	C552	ECEA1HKA3R3B	3.3 50V [M]	C656	ECEA1JU220B	22 63V [M]
C196	ECBT1H102KB5	1000P 50V [M]	C459	ECFR1E223KR	0.022 25V [M]	C553	ECBT1H101KB5	100P 50V [M]	C657	ECCR1H100K5	10P 50V [M]
C351	ECA1CM220B	22 16V [M]	C460	ECFR1E223KR	0.022 25V [M]	C554	ECBT1H101KB5	100P 50V [M]	C658	ECCR1H100K5	10P 50V [M]
C352	ECA1CM220B	22 16V [M]	C461	ECFR1E682KR	6800P 25V [M]	C555	ECBT1H221KB5	220P 50V [M]	C659	ECBT1H221KB5	220P 50V [M]
C353	ECBT1H470J5	47P 50V [M]	C462	ECFR1E682KR	6800P 25V [M]	C556	ECBT1H221KB5	220P 50V [M]	C660	ECBT1H221KB5	220P 50V [M]
C354	ECBT1H470J5	47P 50V [M]	C463	ECEA1VU4R7B	4.7 35V [M]	C557	ECBT1E103ZF5	0.01 25V [M]	C663	ECBT1H681KB5	680P 50V [M]
C355	ECBT1E103ZF5	0.01 25V [M]	C464	ECEA1VU4R7B	4.7 35V [M]	C558	ECBT1E103ZF5	0.01 25V [M]	C664	ECBT1H681KB5	680P 50V [M]
C356	ECBT1E103ZF5	0.01 25V [M]	C465	ECBT1E103ZF5	0.01 25V [M]	C559	ECEA1CKA100B	10 16V [M]	C665	ECA1JM330B	33 6.3V [M]

Ref No	Part No.	Values & Remarks	Ref No.	Part No.	Values & Remarks	Ref No.	Part No.	Values & Remarks	Ref No.	Part No.	Values & Remarks
C666	ECEA2AU100B	10 100V [M]	C755	ECEA1CKA470B	47 16V[M]▲	C949	ECBT1H101KB5	100P 50V [M]	C1028	ECEA1HKAR47B	0.47 50V [M]
C667	ECEA1JU220B	22 63V [M]	C757	ECEA1CKA100B	10 16V[M]▲	C955	ECBT1H101KB5	100P 50V [M]	C1029	ECEA1HKA4R7B	4.7 50V [M]
C668	ECEA2AN2R2SB	2.2 100V [M]	C758	ECA1AM101B	100 10V [M]	C956	ECBT1H101KB5	100P 50V [M]	C1030	ECEA1HKAR47B	0.47 50V [M]
C669	ECBT1H102KB5	1000P 50V [M]	C771	ECA1HM4R7B	4.7 50V [M]	C1001	ECEA1HKA010B	1 50V [M]	C1031	ECQV1H104JM3	0.1 50V [M]
C671	ECEA2AU100B	10 100V [M]	C772	ECA1HM4R7B	4.7 50V [M]	C1002	ECEA1HKA010B	1 50V [M]	C1032	ECQV1H104JM3	0.1 50V [M]
C672	ECEA2AU100B	10 100V [M]	C773	ECBT1E223ZF5	0.022 25V [M]	C1003	ECEA1HKA3R3B	3.3 50V [M]	C1033	ECEA0JKA470B	47 6.3V [M]
C681	ECEA1HN100SB	10 50V [M]	C774	ECA0JM101B	01 6.3V [M]	C1004	ECEA1HKA3R3B	3.3 50V [M]	C1034	ECQV1H474JM3	0.47 50V [M]
C682	ECEA1HN100SB	10 50V [M]	C775	ECFR1E223KR	0.022 25V [M]	C1005	ECEA1HKA010B	1 50V [M]	C1035	ECBT1H681KB5	680P 50V [M]
C683	ECBT1C332KR5	3300P 16V [M]	C901	ECA0JM102B	02 6.3V[M]▲	C1007	ECFR1E223KR	0.022 25V [M]	C1036	ECBT1H101KB5	100P 50V [M]
C684	ECBT1C332KR5	3300P 16V [M]	C902	ECBT1H104ZF5	0.1 50V [M]	C1008	ECFR1E473KR	0.047 25V [M]	C1037	ECBT1H101KB5	100P 50V [M]
C685	ECBT1E103ZF5	0.01 25V [M]	C903	ECBT1E103ZF5	0.01 25V [M]	C1009	ECA0JM221B	220 6.3V[M](EB)	C1038	ECBT1H101KB5	100P 50V [M]
C701	ECBT1E103ZF5	0.01 25V [M]	C904	ECA0JM102B	02 6.3V[M]▲	C1009	ECEA0JU221B	220 6.3V[M](EG,E)	C1039	ECEA1CU101B	100 16V [M]
C702	ECQE2104KF3	0.1 250V [M]	C906	ECEA0JKA101B	100 6.3V[M]▲	C1010	ECEA1CKA100B	10 16V [M]	C1040	ECEA1CKA100B	10 16V[M]▲
C703	EC0S1JP682CB	6800P 63V[M]▲	C908	ECBT1E103ZF5	0.01 25V [M]	C1011	ECEA1CKA100B	10 16V [M]	C1041	ECBT1E103ZF5	0.01 25V [M]
C704	EC0S1JP682CB	6800P 63V[M]▲	C909	ECEA1VKA220B	22 35V[M]▲	C1012	ECEA1CKA100B	10 16V [M]	C1051	ECEA1HKA2R2B	2.2 50V [M]
C705	EC0S1VP562BB	5600P 35V[M]▲	C910	ECEA1VKA220B	22 35V[M]▲	C1013	ECEA1CKA100B	10 16V [M]	C1052	ECEA1HKAR33B	0.33 50V [M]
C706	EC0S1VP562BB	5600P 35V[M]▲	C911	ECEA1VKA220B	22 35V[M]▲	C1014	ECA0JM221B	220 6.3V[M](EB)	C1053	ECEA1HKA3R3B	3.3 50V [M]
C707	ECA1VM101B	100 35V[M]▲	C912	ECEA1VKA220B	22 35V[M]▲	C1014	ECEA0JU221B	220 6.3V[M](EG,E)	C1054	ECA0JM221B	220 6.3V[M](EB)
C708	ECKR1H103ZF5	0.01 50V [M]	C913	ECEA1VKA100B	10 35V [M]	C1015	ECQV1H104JM3	0.1 50V [M]	C1054	ECEA0JU221B	220 6.3V[M](EG,E)
C709	ECA1CM330B	33 16V [M]	C914	ECEA1VKA100B	10 35V[M]▲	C1016	ECQV1H104JM3	0.1 50V [M]	C1055	ECEA1HKAR47B	0.47 50V [M]
C710	ECBT1E103ZF5	0.01 25V [M]	C916	ECEA1HKA010B	1 50V [M]	C1017	ECEA1HKAR47B	0.47 50V [M]	C1056	ECFR1E823KR	0.082 25V [M]
C711	ECKR1H103ZF5	0.01 50V [M]	C917	ECEA1HKAR47B	0.47 50V [M]	C1018	ECEA1HKA4R7B	4.7 50V [M]	C1057	ECFR1E332KR	3300P 25V [M]
C712	ECA1HM100B	10 50V[M]▲	C918	ECEA0JKA221B	220 6.3V [M]	C1019	ECEA1HKAR47B	0.47 50V [M]	C1058	ECFR1E823KR	0.082 25V [M]
C713	ECBT1E103ZF5	0.01 25V [M]	C919	ECBT1E103ZF5	0.01 25V [M]	C1020	ECEA1HKA4R7B	4.7 50V [M]	C1059	ECEA1CKA101B	100 16V [M]
C714	ECA1EM470B	47 25V[M]▲	C920	ECEA1HKA010B	1 50V [M]	C1021	ECEA1HKAR15B	0.15 50V [M]	C1060	ECBT1E223ZF5	0.022 25V [M]
C715	ECEA1CU101B	100 16V [M]	C932	ECBT1H101KB5	100P 50V [M]	C1022	ECEA1HKA3R3B	3.3 50V [M]	C1062	ECBT1E223ZF5	0.022 25V [M]
C721	ECQE2104KF3	0.1 250V [M]	C933	ECBT1H101KB5	100P 50V [M]	C1023	ECQV1H154JM3	0.15 30V [M]	C1063	ECEA1CKA101B	100 16V [M]
C751	ECKWRS102MBC	1000P 400V[M]▲	C934	ECBT1H101KB5	100P 50V [M]	C1024	ECEA1HKA3R3B	3.3 50V [M]	C1064	ECEA1HKA010B	1 50V [M]
C752	ECKR1H103ZF5	0.01 50V [M]	C937	ECBT1H101KB5	100P 50V [M]	C1025	ECQV1H154JM3	0.15 50V [M]	C1065	ECBT1H681KB5	680P 50V [M]
C753	ECA1EM102EV	1000 25V[M]▲	C941	ECBT1H101KB5	100P 50V [M]	C1026	ECEA1HKAR15B	0.15 50V [M]	C1067	ECBT1C152KR5	1500P 16V [M]
C754	ECBT1E103ZF5	0.01 25V [M]	C948	ECBT1H101KB5	100P 50V [M]	C1027	ECEA1HKA4R7B	4.7 50V [M]	C1068	ECBT1C152KR5	1500P 16V [M]

■ Packaging (Refer to page 44 for the Parts List.)

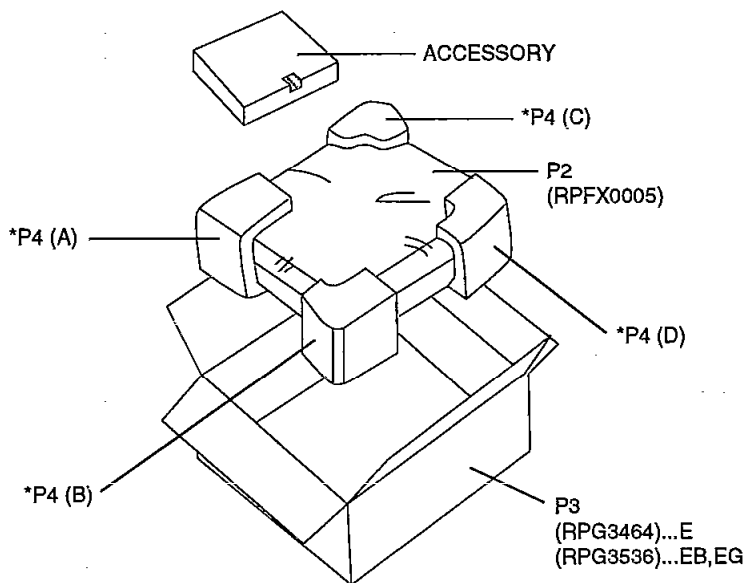

ACCESSORY

P1 (SPSD152)	: ACCESSORY BOX
A1 (EUR644377)	: REMOTE CONTROL UNIT
A2 (RSA0010)	: AM LOOP ANT
A3 (RJA0019-2K)...E,EG	: AC CORD
A3 (VJA0733)...EB	: AC CORD
A4 (RSA0007)	: FM ANTENNA
A5 (RFKSEX510E-K)...E	: INSTR. MANUAL ASS'Y
A5 (RFKSEX510EBK)...EB	: INSTR. MANUAL ASS'Y
A5 (RFKSEX510EGK)...EG	: INSTR. MANUAL ASS'Y
A6 (SJP9009)...EB	: ANT ADAPTER

P4 (RPN0966) — \*P4 (A)  
 \*P4 (B)  
 \*P4 (C)  
 \*P4 (D)

MESA Printed in Singapore  
 G970808000 J/N/S/K/L